



DESIGN / BUILD / INNOVATE  
DISEÑAR / CONSTRUIR / INNOVAR

# GENERAL CATALOGUE CATÁLOGO GENERAL



2025











# 30 YEAR SERVICE LIFE AÑOS DE VIDA ÚTIL



## DESIGN

All products are designed at our factory in Pamplona.

Our design guidelines are functionality, ergonomics, asepsis, a tasteful design.

## BUILD

The components used are mainly manufactured in Spain and Germany.

We cooperate with a network of approximately 60 suppliers.

The components designed by Insausti technical office are manufactured in suppliers production plants.

All trolleys and accessories are assembled upon request at our factory in Pamplona.

## INNOVATE

Insausti products are developed for health professionals who think long-term and wish to offer their patients an excellent human and technical service.

## DISEÑAR

Todos los productos se diseñan en nuestra fábrica de Pamplona.

Las pautas de diseño son funcionalidad, ergonomía, asepsia, cuidado de la estética.

## CONSTRUIR

Los componentes utilizados se fabrican principalmente en España y Alemania. Colaboramos con una red de 60 proveedores aproximadamente.

Los componentes diseñados en la oficina técnica de Insausti se fabrican en las plantas de producción de los proveedores.

Todos los carros y los accesorios se ensamblan bajo pedido en nuestra fábrica de Pamplona.

## INNOVAR

Los productos de Insausti se desarrollan para los profesionales de la salud que piensan a largo plazo, que desean ofrecer a los pacientes un servicio humano y técnico excelente.

## INDEX ÍNDICE

<b>1 - TECHNICAL FEATURES CARACTERÍSTICAS TÉCNICAS</b>	6
<b>2 - MEDICAL TROLLEYS CARROS MÉDICOS</b>	
LOW TROLLEYS CARROS BAJOS	16
MULTIFUNCTION MULTIFUNCIÓN	
SQS SERIES SERIE	18
300 SERIES SERIE	22
PLASTER TROLLEY CARRO DE YESOS	28
DIFFICULT INTUBATION / ISOLATION INTUBACIÓN DIFÍCIL / AISLAMIENTO	29
MRI	30
OPERATING ROOM QUIRÓFANO	
ANAESTHESIA ANESTESIA	33
CATHETER TROLLEYS CARROS DE CATÉTERES	38
STORAGE TROLLEYS CARROS DE ALMACÉN	40
EMERGENCY EMERGENCIA	
SQM SERIES SERIE	44
PAEDIATRIC PEDIÁTRICA	46
100 SERIES SERIE	47
TREATMENT CURAS	
SQM SERIES SERIE	52
100 SERIES SERIE	54
TRANSPORT TROLLEYS WITH CASSETTES CARROS DE TRANSPORTE CON CASETES	60
UNIT DOSE MEDICATION MEDICACIÓN UNIDOSIS	62
TRANSPORT TROLLEYS CARROS DE TRANSPORTE	68
<b>3 - BASIC TROLLEYS CARROS BÁSICOS</b>	
SQS SQUARE TROLLEYS CARROS CUADRADOS	74
OPEN TROLLEYS CARROS ABIERTOS	75
300 SIMPLE TROLLEYS CARROS SIMPLES	76
300 DOUBLE TROLLEYS CARROS DOBLES	78
LOW TROLLEYS CARROS BAJOS	80
SQM SQUARE TROLLEYS CARROS CUADRADOS	82
100 SIMPLE TROLLEYS CARROS SIMPLES	83
<b>4 - ACCESSORIES ACCESORIOS</b>	84



**TECHNICAL FEATURES CARACTERÍSTICAS TÉCNICAS**

**SQUARE TROLLEY CARRO CUADRADO**

~~ISO~~ **480 x 480 mm**

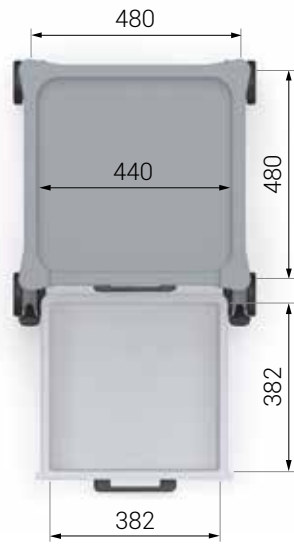

**SQS**



**SQM**



**DOUBLE TROLLEY CARRO DOBLE**

**ISO 900 x 630 mm**

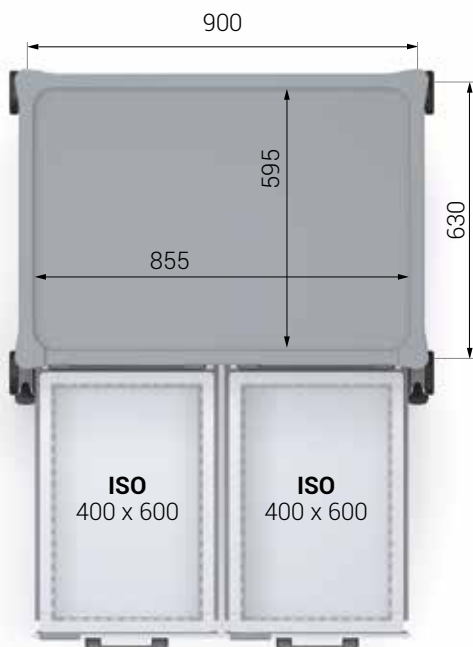

**300 SERIES SERIE**

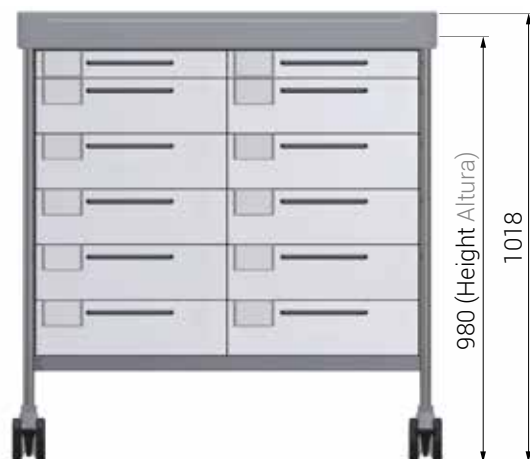

# TECHNICAL FEATURES CARACTERÍSTICAS TÉCNICAS

## SIMPLE TROLLEY CARRO SIMPLE

**ISO 640 x 480 mm**

ISO International Organization for Standardisation, ISO norm 3394  
600 x 400 mm ISO drawers. Standard, interchangeable with hospital ISO furniture

ISO Organización Internacional de Normalización, norma ISO 3394  
Cajones ISO 600 x 400 mm. Estándar, intercambiables con el mobiliario ISO del hospital

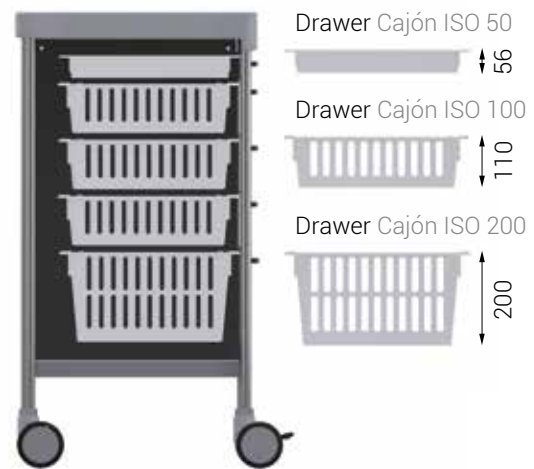
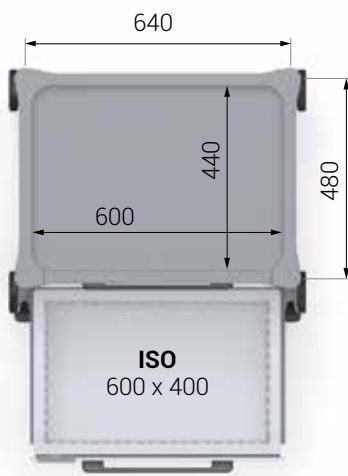

### LOW BAJO

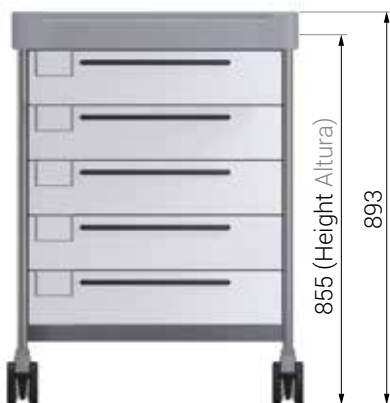

### 300 SERIES SERIE



### 100 SERIES SERIE





**TECHNICAL FEATURES CARACTERÍSTICAS TÉCNICAS**

~~ISO~~

**SQUARE TROLLEY CARRO CUADRADO CE**

**480 x 480 mm**

SOFT CLOSING SLIDES (Optional)  
No closing noise is produced  
Operating room, reanimation area, ICU

CORREDERAS CIERRE SUAVE (Opcional)  
No se produce ruido de cierre  
Quirófano, URPA, UCI



**ASF**



Prepared for elevated accessories

Preparado para accesorios elevados

**PE**  
**SANITIZED**   
**DESINFECTADO**

Ergonomic handle

Asa ergonómica

Total opening  
Steel ball-bearing slides  
with retention system, 20 kg

Apertura total  
Correderas de bolas de  
acero con sistema de  
retención, 20 kg

**PP**  
**SANITIZED**  
**DESINFECTADO**



Cap Tapón

Front stop  
It protects the slide against  
strong impacts when closing

Tope frontal  
Protege la corredera contra  
fuertes impactos de cierre

Prepared for ref. 32R, 37R, 39, 50, 51, 57

Preparado para ref. 32R, 37R, 39, 50, 51, 57

**TECHNICAL FEATURES CARACTERÍSTICAS TÉCNICAS**

**ISO**

**SIMPLE TROLLEY CARRO SIMPLE** **CE**  
**DOUBLE TROLLEY CARRO DOBLE** **CE**

**640 x 480 mm**  
**900 x 630 mm**

**SOFT CLOSING SLIDES (Optional)**  
 No closing noise is produced  
 Operating room, reanimation area, ICU

**CORREDERAS CIERRE SUAVE (Opcional)**  
 No se produce ruido de cierre  
 Quirófano, URPA, UCI



Prepared for elevated accessories  
 Preparado para accesorios elevados



**ASF Simple trolley Carro simple**  
**ASFN Double trolley Carro doble**

**PE**  
**SANITIZED**   
**DESINFECTADO**



Ergonomic handle  
 Asa ergonómica

Total opening  
 Steel ball-bearing slides with retention system, 20 kg

Apertura total  
 Correderas de bolas de acero con sistema de retención, 20 kg

**PE**  
**SANITIZED**   
**DESINFECTADO**

**ABS**

Front stop  
 It protects the slide against strong impacts when closing

Topo frontal  
 Protege la corredera contra fuertes impactos de cierre

Prepared for ref. 32L, 37L, 32NL, 37NL  
 Preparado para ref. 32L, 37L, 32NL, 37NL



## **TECHNICAL FEATURES CARACTERÍSTICAS TÉCNICAS**

### **MONOBLOC STRUCTURE ESTRUCTURA MONOBLOQUE**

AISI-304 stainless steel  
Assembly with rivets and TIG welding  
Side panels prepared for accessories (holes with caps)

Acero inoxidable AISI-304  
Ensamblaje con remaches y soldadura TIG  
Paneles laterales preparados para accesorios (agujeros con tapones)



### **PE, PP SANITIZED DESINFECTADO**

Withstand disinfectants for the elimination of pathogens  
Withstand 100% pure alcohol (not diluted), bleach, detergent, soap solutions, oils, polish, aqueous ammonia, chlorhexidine  
Withstand constant cleaning protocols, they do not degrade

Resisten los desinfectantes para la eliminación de los agentes patógenos  
Resisten alcohol puro 100% (sin diluir), lejía, detergente, soluciones jabonosas, aceites, grasas, amoníaco acuoso, clorhexidina  
Resisten protocolos de limpieza constantes, no se degradan

### **PE, POLYETHYLENE WORK SURFACE**

#### **SUPERFICIE DE TRABAJO DE POLIETILENO**

Protection on all 4 sides  
Protección en los 4 lados



## TECHNICAL FEATURES CARACTERÍSTICAS TÉCNICAS

### PP, POLYPROPYLENE SQUARE DRAWERS

~~ISO~~ 480 x 480 mm

### PP, CAJONES CUADRADOS DE POLIPROPILENO

Polypropylene drawers, PP, manufactured in a single piece with slots for optional dividers.  
Heights 57, 130 mm.

Cajones de polipropileno, PP, fabricados en una única pieza con ranuras para separadores opcionales.  
Alturas 57, 130 mm.



### ISO DRAWERS CAJONES ISO 600 x 400 mm

ISO 640 x 480 mm

ABS ISO drawers of standard dimensions according to ISO 3394.  
Heights 50, 100, 200 mm.

900 x 630 mm

Cajones ISO de ABS de medidas estándar según norma ISO 3394.  
Alturas 50, 100, 200 mm.





## TECHNICAL FEATURES CARACTERÍSTICAS TÉCNICAS



### STATIC TROLLEYS CARROS ESTÁTICOS

#### SQS SERIES SERIE - 480 x 480 mm

- The work surface design allows you to move the trolley easily
- Ø 100 mm wheels, 2 antistatic, 2 with brake
- El diseño de la superficie de trabajo permite manejar el carro con facilidad
- Ruedas Ø 100 mm, 2 antiestáticas, 2 con freno

CE



#### 300 SERIES SERIE - ISO 640 x 480 mm

- The work surface design allows you to move the trolley easily
- Ø 100 mm wheels, 2 antistatic, 2 with brake
- El diseño de la superficie de trabajo permite manejar el carro con facilidad
- Ruedas Ø 100 mm, 2 antiestáticas, 2 con freno

CE



#### 300 SERIES SERIE - ISO 900 x 630 mm

- The work surface design allows you to move the trolley easily
- Ø 100 mm wheels, 2 antistatic, 2 with brake
- El diseño de la superficie de trabajo permite manejar el carro con facilidad
- Ruedas Ø 100 mm, 2 antiestáticas, 2 con freno

CE



#### 700 SERIES SERIE - ISO 640 x 480 / 900 x 630 mm

- Phenolic or methacrylate doors
- Key locking
- Handles, left side
- Ø 100 mm wheels, 2 antistatic, 2 with brake
- Puertas de fenólico o metacrilato
- Bloqueo de llave
- Asas, lado izquierdo
- Ruedas Ø 100 mm, 2 antiestáticas, 2 con freno



## TECHNICAL FEATURES CARACTERÍSTICAS TÉCNICAS



### EXTENSIVE MOBILITY TROLLEYS

### CARROS ALTA MOVILIDAD

#### SQM SERIES SERIE - 480 x 480 mm

- Elevated push handle, left side
- Bumpers for hits
- Ø 125 mm simple wheels, 2 antistatic, 2 with brake
- Tirador elevado, lado izquierdo
- Protectores paragolpes
- Ruedas simples Ø 125 mm, 2 antiestáticas, 2 con freno



CE



#### 100 SERIES SERIE - ISO 640 x 480 mm

- Elevated push handle, left side
- Bumpers for hits
- Ø 125 mm double wheels, 2 antistatic, 2 with brake
- Tirador elevado, lado izquierdo
- Protectores paragolpes
- Ruedas dobles Ø 125 mm, 2 antiestáticas, 2 con freno



CE



#### 500 SERIES SERIE - 480 x 480 mm - 640 x 480 mm - 900 x 570 mm

- Elevated push handle, left side
- Bumpers for hits
- Ø 125 mm simple wheels, 2 antistatic, 2 with brake
- Tirador elevado, lado izquierdo
- Protectores paragolpes
- Ruedas simples Ø 125 mm, 2 antiestáticas, 2 con freno



#### 600 SERIES SERIE - 640 x 480 / 900 x 630 mm

- Phenolic or methacrylate doors
- Key locking
- Handles, both sides
- Ø 125 mm double wheels, 2 antistatic, 2 with dual lock
- Puertas de fenólico o metacrilato
- Bloqueo de llave
- Asas, ambos lados
- Ruedas dobles Ø 125 mm, 2 antiestáticas, 2 con doble bloqueo



Fixed wheel  
Rueda fija



Swivel wheel  
Rueda giratoria



Locked wheel  
Rueda bloqueada



## TECHNICAL FEATURES CARACTERÍSTICAS TÉCNICAS

### SQUARE TROLLEY CARRO CUADRADO

Drawer colour Color de cajones



**W** White Blanco



**B** Blue Azul



**R** Red Rojo

### SIMPLE TROLLEY / DOUBLE TROLLEY CARRO SIMPLE / CARRO DOBLE

Front drawer colour Color de frentes de cajón



**W** White Blanco



**B** Blue Azul



**F** Lilac Lila



**G** Green Verde



**Y** Yellow Amarillo



**R** Red Rojo

### 600 / 700 SERIES SERIE

Doors Puertas



**DN** HPL phenolic, light grey  
HPL fenólico, gris claro



**TT** Transparent methacrylate  
Metacrilato transparente

## TECHNICAL FEATURES CARACTERÍSTICAS TÉCNICAS

Plastic material. ISO norm 7810 identification card, international standard

Material plástico. Tarjeta de identificación norma ISO 7810, estándar internacional

### SQUARE TROLLEY CARRO CUADRADO

Each drawer includes as standard one white card

Cada cajón incluye de serie una tarjeta blanca

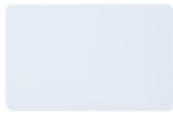

White card  
Tarjeta blanca

### SIMPLE TROLLEY / DOUBLE TROLLEY CARRO SIMPLE / CARRO DOBLE

Each drawer includes as standard one card holder and one white card

Cada cajón incluye de serie un portatarjetas y una tarjeta blanca



Card holder  
Portatarjetas

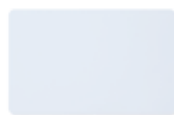

White card  
Tarjeta blanca

### COLOUR CARDS (Optional) TARJETAS DE COLORES (Opcional)



**CR** Red Rojo



**CG** Green Verde



**CP** Pink Rosa



**CB** Blue Azul



**CO** Orange Naranja



**CF** Lilac Lila



**CY** Yellow Amarillo



**CN** Grey Gris



**SQ061 W.CR.CP.CO.CY.CG.CB**



**LOW TROLLEYS, REDUCED HEIGHT**  
**CARROS BAJOS, ALTURA REDUCIDA** **CE**

~~ISO~~

**480 x 480 mm**

**GYNECOLOGY, PHLEBOTOMY, OUTPATIENTS CLINICS**  
**GINECOLOGÍA, EXTRACCIONES, CONSULTAS EXTERNAS**



**STATIC TROLLEYS**  
**CARROS ESTÁTICOS**

**DIVIDERS (Optional)**  
**SEPARADORES (Opcional)**



**8 DMQ, 6 DSQ**

- DISPOSABLE CONTAINER
- ALCOHOL, CHLORHEXIDINE JARS

- CONTENEDOR DESECHABLE
- BOTES ALCOHOL, CLORHEXIDINA



**Q002LW B**  
**SQ061M4LW B.26LW(R1Q)**

**LOW TROLLEYS, REDUCED HEIGHT**  
**CARROS BAJOS, ALTURA REDUCIDA** **CE**

~~ISO~~

**480 x 480 mm**



**STATIC TROLLEYS**  
**CARROS ESTÁTICOS**

To store it under 900 mm work tables  
 For users working in sitting position

Para guardarlos debajo de mesas de trabajo de 900 mm  
 Para el usuario que trabaja en posición sentada



**Q011LW W**  
 SQ064M4LW W.26LW(R2Q).33R.50  
 Phlebotomy Extracciones



**Q001LW B**  
 SQ061M4LW B.32R



**Q003LW W**  
 SQ061M4LW W.26LW(R1Q).30.33L



**Q004LW W**  
 SQ061M4LW W.26(RA4Q.A5).32R



**3100LW W**  
 362M5LW W.32R



**3103LW B**  
 362M5LW B.32L.33R.50



**3105LW G**  
 362M5LW G.26(RA4.A5).32R

**ISO 640 x 480 mm**

**MULTIFUNCTION MULTIFUNCIÓN**  
**SQS SERIES SERIE CÉ**

~~ISO~~

**480 x 480 mm**

ICU, CARDIOLOGY, DRESSING, OUTPATIENTS CLINICS

UCI, CARDIOLOGÍA, VENDAJES, CONSULTAS EXTERNAS



**STATIC TROLLEYS**  
**CARROS ESTÁTICOS**

DIVIDERS (Optional)  
SEPARADORES (Opcional)



**8 DMQ, 8 DSQ**

SYRINGES

JERINGUILLAS



DISPOSABLE  
CONTAINER

CONTENEDOR  
DESECHABLE

**Q091 B**  
SQ061 B.26(RA4Q.A5).32R

**MULTIFUNCTION MULTIFUNCIÓN**  
**SQS SERIES SERIE CE**

~~ISO~~  
**480 x 480 mm**

ICU, CARDIOLOGY, DRESSING, OUTPATIENTS CLINICS

UCI, CARDIOLOGÍA, VENDAJES, CONSULTAS EXTERNAS



**STATIC TROLLEYS**  
**CARROS ESTÁTICOS**

**DIVIDERS (Optional)**  
**SEPARADORES (Opcional)**



**8 DMQ, 8 DSQ**

SYRINGES

JERINGUILLAS

DISPOSABLE  
 CONTAINER

CONTENEDOR  
 DESECHABLE



FOLD  
 DOWN TRAY

BANDEJA  
 ABATIBLE

**Q096 W**

SQ061 W.26(RA4Q.A5).30.32L



# MULTIFUNCTION MULTIFUNCIÓN

## SQS SERIES SERIE CÉ

~~ISO~~

**480 x 480 mm**

ICU, CARDIOLOGY, DRESSING, OUTPATIENTS CLINICS

UCI, CARDIOLOGÍA, VENDAJES, CONSULTAS EXTERNAS



**STATIC TROLLEYS**  
CARROS ESTÁTICOS

DIVIDERS (Optional)  
SEPARADORES (Opcional)



**8 DMQ, 8 DSQ**

SYRINGES

JERINGUILLAS

ALCOHOL, CHLORHEXIDINE JARS

BOTES ALCOHOL, CLORHEXIDINA

DISPOSABLE  
CONTAINER

CONTENEDOR  
DESECHABLE

FOLD  
DOWN TRAY

BANDEJA  
ABATIBLE



**Q092 W.(6)CP**

SQ061 W.26(RA5Q.A5.R1Q).30.33L.(6)CP

**MULTIFUNCTION MULTIFUNCIÓN**  
**SQS SERIES SERIE CÉ**

~~ISO~~  
**480 x 480 mm**



**STATIC TROLLEYS**  
**CARROS ESTÁTICOS**



**Q024 W**  
 SQ021 W.26LW(R1Q)



**Q025 W**  
 SQ022 W.32R



**Q027 B**  
 SQ021TXQ B.26M(R75QM)



**Q054 B**  
 SQ061 B.32R



**Q058 B**  
 SQ061 B.32R.46



**Q063 W**  
 SQ061 W.32L.33R.50



**Q064 W**  
 SQ061 W.26(RA4Q.A5).32L.33R.50



**Q072 B**  
 SQ061 B.30.32L



**Q077 W**  
 SQ061 W.26LW(R1Q).30.33L

**MULTIFUNCTION MULTIFUNCIÓN**  
**300 SERIES SERIE CE**

**ISO**  
**640 x 480 mm**

ICU, CARDIOLOGY, DRESSING, OUTPATIENTS CLINICS  
UCI, CARDIOLOGÍA, VENDAJES, CONSULTAS EXTERNAS

 **STATIC TROLLEYS**  
**CARROS ESTÁTICOS**

- ALCOHOL,  
CHLORHEXIDINE JARS
- GLOVE BOX
- BOTES ALCOHOL,  
CLORHEXIDINA
- CAJA DE GUANTES

DIVIDERS (Optional)  
SEPARADORES (Opcional)



H5/8, (3)H10/4, H20/4



DISPOSABLE  
CONTAINER

CONTENEDOR  
DESECHABLE



Contaminated  
waste on right side

Desechos  
contaminados en  
lado derecho

WASTE BIN  
CUBO DESECHOS

**3151 B**  
365 B.26LW(R1).33R.50

**MULTIFUNCTION MULTIFUNCIÓN**  
**300 SERIES SERIE CE**

**ISO**  
**640 x 480 mm**

ICU, CARDIOLOGY, DRESSING, OUTPATIENTS CLINICS

UCI, CARDIOLOGÍA, VENDAJES, CONSULTAS EXTERNAS



**STATIC TROLLEYS**  
**CARROS ESTÁTICOS**

DIVIDERS (Optional)  
 SEPARADORES (Opcional)



H5/8, (3)H10/4, H20/4

- ALCOHOL,  
CHLORHEXIDINE JARS
- DISPOSABLE CONTAINER

- BOTES ALCOHOL,  
CLORHEXIDINA
- CONTENEDOR DESECHABLE



3 GLOVE BOX

3 CAJAS DE  
 GUANTES

WASTE BIN  
 CUBO DESECHOS

**3133 W**  
 365 W.26LW(R1).46.50



# MULTIFUNCTION MULTIFUNCIÓN OPEN TROLLEY CARRO ABIERTO **CE**

**ISO**

**640 x 480 mm**

ICU, CARDIOLOGY, DRESSING, OUTPATIENTS CLINICS

UCI, CARDIOLOGÍA, VENDAJES, CONSULTAS EXTERNAS



**STATIC TROLLEYS**  
**CARROS ESTÁTICOS**



Retention stop rails  
Guías con tope de retención



**365AB**

CENTRAL SUPPORT (Optional)  
SOPORTE CENTRAL (Opcional)



**26LW(R1)**

SIDE SUPPORT (Optional)  
SOPORTE LATERAL (Opcional)



**32R**

BIN (Optional)  
CUBO (Opcional)



**50AB - 13 Litres Litros**  
**50BAB - 2 x 13 Litres Litros**  
**51AB - 26 Litres Litros**

**MULTIFUNCTION MULTIFUNCIÓN**  
**300 SERIES SERIE CÉ**

**ISO**  
**640 x 480 mm**



**STATIC TROLLEYS**  
**CARROS ESTÁTICOS**



**3102 B**  
 322 B.32R



**3107 G**  
 333 G.32R



**3105 Y**  
 332 Y.26LW(R1)



**3129 W**  
 365 W.32R



**3127 B**  
 365 B.32R.46



**3153 W**  
 365 W.(2)32L.33R.50



**3140 B**  
 365 B.26LW(R1).30.46.50



**3157 W**  
 365 W.26(R1.R1).33R.50



**3145 G**  
 365 G.26(RA5.A5.R1).32R

**MULTIFUNCTION MULTIFUNCIÓN**  
**300 SERIES SERIE CE**

**ISO**  
**900 x 630 mm**

TRAUMATOLOGY, DRESSING, SURGERY  
TRAUMATOLOGÍA, VENDAJES, CIRUGÍA



**STATIC TROLLEYS**  
**CARROS ESTÁTICOS**

DIVIDERS (Optional)  
SEPARADORES (Opcional)

- ALCOHOL,  
CHLORHEXIDINE JARS
- GLOVE BOX
- BOTES ALCOHOL,  
CLORHEXIDINA
- CAJA DE GUANTES



(2)H5/8, (6)H10/4, (2)H20/4



DISPOSABLE  
CONTAINER

CONTENEDOR  
DESECHABLE

**3820 B**  
N365 B.26LW(R1N).32NR

**MULTIFUNCTION MULTIFUNCIÓN**  
**300 SERIES SERIE CÉ**

**ISO**  
**900 x 630 mm**

TRAUMATOLOGY, DRESSING, SURGERY  
 TRAUMATOLOGÍA, VENDAJES, CIRUGÍA



**STATIC TROLLEYS**  
**CARROS ESTÁTICOS**



**3808**  
 N305.26LW(R1N)



**3800 G**  
 N322 G.26LW(R1N)



**3818 W**  
 N365 W.26LW(R1N)



**3830 Y**  
 N365 Y.26(R2N.R1N)



**3840 W**  
 N365 W.26(R7N.R7N).32NR



**3850 G**  
 N365 G.26(RA4N.A5).32NR



**3860 W**  
 N362M12 W.26(RA4N.A5).(2)32NR



# PLASTER TROLLEY CARRO DE YESOS 300 SERIES SERIE CÉ

**ISO  
900 x 630 mm**

Stainless steel AISI-304 monobloc structure.

Polyethylene work surface, PE

**LXN** Stainless steel protection, resists contact with fiberglass bandages

Estructura monobloque de acero inoxidable AISI-304

Superficie de trabajo de polietileno, PE

**LXN** Protección de acero inoxidable, resiste el contacto de vendas con fibra de vidrio

**BANDAGE SHELF ROLLS  
ESTANTE ROLLOS VENDAS**

5 dividers, adjustable  
5 separadores, regulables



**R12N**

**1 PLASTER-BASIN SUPPORT  
SOPORTE 1 CUBETA PARA YESO**

8.8 litres, PC transparent  
Removable, supports on ref. 37NR

8.8 litros, PC transparente  
Desmontable, apoya en ref. 37NR



**49**



**3892 W**

N322 W.LXN.26(R12N.R2N).37NR.49

**DIFFICULT INTUBATION INTUBACIÓN DIFÍCIL**  
**300 SERIES SERIE CÉ**

**ISO**  
**640 x 480 mm**



**3702 W**  
 364M6 W.12B.14.32R



**3708 W**  
 364M6 W.12B.14.26LW(R2).32R.36.44L

SUCTION UNIT SUPPORT  
 (Optional)  
 SOPORTE ASPIRADOR  
 (Opcional)



**39**

**ISOLATION AISLAMIENTO**  
**300 SERIES SERIE CÉ**

**ISO**  
**640 x 480 mm**

Infection control

To store protective disposable material, clothes, caps, masks, gloves, hose

Control de infecciones

Para almacenar material desechable de protección, ropa, gorros, mascarillas, guantes, calzas



**3732 Y**  
 366M6 Y.46



**3738 Y**  
 366M6 Y.46.48L.51

GOWN SUPPORT  
 (Optional)  
 SOPORTE PARA BATAS  
 (Opcional)



**41**

 **STATIC TROLLEYS**  
**CARROS ESTÁTICOS**



**3 Tesla**

Certificate of MRI conformance  
Certificado de conformidad MRI

**DIVIDERS (Optional)**  
**SEPARADORES (Opcional)**



**H5/8, (3)H10/4, H20/4**

**SYRINGES**

**JERINGUILLAS**

**KEY LOCKING**

(Optional)

**BLOQUEO DE LLAVE**

(Opcional)



**10MR**

- DISPOSABLE  
CONTAINER  
- GLOVE BOX

- CONTENEDOR  
DESECHABLE  
- CAJA DE GUANTES

**3 GLOVE BOX HOLDER**

(Optional)

**SOPORTE 3 CAJAS DE  
GUANTES (Opcional)**



**46**

**BIN (Optional)**

**CUBO (Opcional)**



**50MR - 13 Litres Litros**

**51MR - 26 Litres Litros**



**3607MRI G**

365MRI G.26(RA4.A5).32R

Anaesthesia

Anestesia

**MRI ROOM SALA DE RESONANCIA MAGNÉTICA MRI** **CE**

**ISO**  
**640 x 480 mm**

 **STATIC TROLLEYS**  
**CARROS ESTÁTICOS**

Trolley manufactured with antimagnetic materials  
4 antistatic wheels with brake

Carro fabricado con materiales antimagnéticos  
4 ruedas antiestáticas con freno



**3 Tesla**

Certificate of MRI conformance  
Certificado de conformidad MRI



**305MRI**

Multifunction  
Multifunción



**3102MRI B**  
322MRI B.32R

Multifunction  
Multifunción



**3126MRI W**  
364MRI W.32R

Multifunction  
Multifunción



**3129MRI Y**  
365MRI Y.32R

Multifunction  
Multifunción



**3232MRI R**  
365MRI R.12MR.14.(2)32R.36MR.41

Emergency  
Emergencia



**706MRI OP.(2)60.(4)72.73**

Storage  
Almacén

# OPERATING ROOM QUIRÓFANO





**ANAESTHESIA ANESTESIA**  
**300 SERIES SERIE CE**

**ISO**  
**900 x 630 mm**

**OPERATING ROOM**  
**QUIRÓFANO**

 **STATIC TROLLEYS**  
**CARROS ESTÁTICOS**

**DIVIDERS (Optional)**  
**SEPARADORES (Opcional)**

**SYRINGES**  
**JERINGUILLAS**

- MEDICATION LABELS DISPENSER
- GLOVE BOX
- DISPENSADOR ETIQUETAS DE MEDICACIÓN
- CAJA DE GUANTES



**(2)H5/16, (6)H10/4, (2)H20/4**

**DISPOSABLE CONTAINER**  
**CONTENEDOR DESECHABLE**



**3956 G**  
**N365 G.26(RA4N.A5.R2N).32NR**

**ANAESTHESIA ANESTESIA  
300 SERIES SERIE CE**

**ISO  
640 x 480 mm**

EMERGENCY ROOM, OPERATING ROOM, REANIMATION AREA  
SERVICIO URGENCIAS, QUIRÓFANO, URPA



**STATIC TROLLEYS  
CARROS ESTÁTICOS**

DIVIDERS (Optional)  
SEPARADORES (Opcional)



**H5/16, (3)H10/4, H20/4**

SYRINGES

JERINGUILLAS



- DISPOSABLE CONTAINER
- GLOVE BOX
- CONTENEDOR DESECHABLE
- CAJA DE GUANTES

**3607 G**  
365 G.26(RA4.A5).32R

**ANAESTHESIA ANESTESIA**  
**300 SERIES SERIE CE**

**ISO**  
**640 x 480 mm**

**OPERATING ROOM**  
**QUIRÓFANO**

 **STATIC TROLLEYS**  
**CARROS ESTÁTICOS**

**DIVIDERS (Optional)**  
**SEPARADORES (Opcional)**



**H5/16, (3)H10/4, H20/4**

**SYRINGES**  
**JERINGUILLAS**

- **MEDICATION LABELS DISPENSER**  
 - **GLOVE BOX**

- **DISPENSADOR ETIQUETAS DE**  
**MEDICACIÓN**  
 - **CAJA DE GUANTES**

**DISPOSABLE**  
**CONTAINER**  
**CONTENEDOR**  
**DESECHABLE**



**FOLD**  
**DOWN TRAY**  
**BANDEJA**  
**ABATIBLE**

**3684 B**  
 365 B.26(RA4.A5.R2).30.32L

**ANAESTHESIA ANESTESIA  
300 SERIES SERIE CÉ**

**ISO  
640 x 480 mm**

EMERGENCY ROOM, OPERATING ROOM, REANIMATION AREA  
SERVICIO URGENCIAS, QUIRÓFANO, URPA



**STATIC TROLLEYS  
CARROS ESTÁTICOS**

**ANAESTHESIA TROLLEY PREPARED FOR DIGITALIZATION  
CARRO DE ANESTESIA PREPARADO PARA DIGITALIZACIÓN**

COMPUTER  
ORDENADOR

VESA SUPPORT  
3 POSITIONS,  
ADJUSTABLE  
SOPORTE VESA  
3 POSICIONES,  
REGULABLE

- DISPOSABLE CONTAINER
- ALCOHOL, CHLORHEXIDINE JARS
- CONTENEDOR DESECHABLE
- BOTES ALCOHOL, CLORHEXIDINA

DIVIDERS (Optional)  
SEPARADORES (Opcional)



H5/16, (3)H10/4, H20/4

FOLD DOWN TRAY  
BANDEJA ABATIBLE



**3695 W**  
362M6TX W.26M(R75M).30.(2)32L

**ANAESTHESIA ANESTESIA**  
**300 SERIES SERIE CE**

**ISO**  
**640 x 480 mm**



**STATIC TROLLEYS**  
**CARROS ESTÁTICOS**



**3613 W**  
 362M6 W.26(RA4.A5).32R



**3611 G**  
 365 G.26(RA4.A5).27EV.32R



**3650 G**  
 365 G.26(RA4.A5).30.(2)32L



**3680 Y**  
 365 Y.26(RA5.A5.R1).30.33L



**3609 Y**  
 365 Y.26(RA4.A5).(2)32R.33L



**3685 B**  
 365 B.26(RA4.A5.R2).30.(2)32L



**3687 B**  
 365 B.26(RA4.A5.R2).30.33L.44L



**3694 W**  
 362M6 W.26(RA4.A5.R2).30.32L



# CATHETER TROLLEY CARRO DE CATÉTERES 700 SERIES SERIE

**ISO  
640 x 480 mm**



Adjustable shelf, phenolic  
600 x 400 mm ISO drawers

Bandeja regulable, fenólico  
Cajones ISO 600 x 400 mm

**DN** Light grey doors Puertas gris claro

**TT** Transparent doors Puertas transparentes



**706 DN.60CAT**

**CATHETERS SHELF  
BANDEJA PARA CATÉTERES**  
25 hooks 25 colgadores



**60CAT**

**CATHETERS RAIL, 3 HOOKS  
(Optional)  
RIEL PARA CATÉTERES, 3 GANCHOS  
(Opcional)**

Catheters maximum height 1780 mm  
Altura máxima catéteres 1780 mm



**R7CAT3**

**CATHETER TROLLEY CARRO DE CATÉTERES  
700 SERIES SERIE**

**ISO  
900 x 630 mm**



**STATIC TROLLEYS  
CARROS ESTÁTICOS**

Adjustable shelf, phenolic  
400 x 600 mm ISO drawers

Bandeja regulable, fenólico  
Cajones ISO 400 x 600 mm

**DN** Light grey doors Puertas gris claro  
**TT** Transparent doors Puertas transparentes



**720 TT.62CAT.(2)62.(4)72.73**

**CATHETERS SHELF  
BANDEJA PARA CATÉTERES**  
15 hooks 15 colgadores



**62CAT**

**CATHETERS RAIL, 4 HOOKS  
(Optional)  
RIEL PARA CATÉTERES, 4 GANCHOS  
(Opcional)**  
Catheters maximum height 1780 mm  
Altura máxima catéteres 1780 mm



**R7CAT4**

**STORAGE TROLLEY CARRO DE ALMACÉN  
700 SERIES SERIE**

**ISO  
900 x 630 mm**

Monobloc structure of AISI-304 stainless steel  
 Assembly with rivets and TIG welding  
 Doors with key locking  
 400 x 600 mm ISO drawers  
 Maximum capacity 10 + 10 = 20 ISO drawers 100 mm height

Estructura monobloque de acero inoxidable AISI-304  
 Ensamblaje con remaches y soldadura TIG  
 Puertas con bloqueo de llave  
 Cajones ISO 400 x 600 mm  
 Capacidad máxima 10 + 10 = 20 cajones ISO altura 100 mm

**DN** Light grey doors Puertas gris claro  
**TT** Transparent doors Puertas transparentes



**720 DN.(3)62.(6)72.(2)73**

UPPER SUPPLEMENT (Optional)  
 SUPLEMENTO SUPERIOR (Opcional)



**68B**

ADJUSTABLE SHELF (Optional)  
 BANDEJA REGULABLE (Opcional)



**62 - 400 x 600 mm**

RETENTION STOP (Optional)  
 TOPE DE RETENCIÓN (Opcional)  
 1 set per drawer 1 juego por cajón



**TR**

**STORAGE TROLLEYS CARROS DE ALMACÉN**  
**700 SERIES SERIE**

**ISO**  
**640 x 480 mm**

RETENTION STOP (Optional)  
 TOPE DE RETENCIÓN (Opcional)  
 1 set per drawer 1 juego por cajón



**TR**

**DN** Light grey doors Puertas gris claro  
**TT** Transparent doors Puertas transparentes

UPPER SUPPLEMENT (Optional)  
 SUPLEMENTO SUPERIOR (Opcional)



**68**



706 OP.(8)72.73



706 DN.(3)60.(2)72.73



706 DN.(2)60.(4)72.73



706 DN.(2)60.(2)72.(2)73



706 DN.(6)72.(2)73

# EMERGENCY EMERGENCIA





# EMERGENCY EMERGENCIA



**EMERGENCY EMERGENCIA**  
**SQM SERIES SERIE C€**

~~ISO~~  
**480 x 480 mm**

 **EXTENSIVE MOBILITY TROLLEYS**  
**CARROS ALTA MOVILIDAD**

SIMPLE WHEELS RUEDAS SIMPLES Ø 125 mm



DIVIDERS (Optional)  
SEPARADORES (Opcional)



**Bexen cardio**

DEFIBRILLATOR  
2 ROTATION AXLES

DESFIBRILADOR  
2 EJES DE GIRO

**12 DMQ, 8 DSQ**

SERUM  
SUEROS

CPR BOARD  
TABLA RCP

GAS BOTTLE  
Ø 110 / 140  
BOTELLA DE GAS  
Ø 110 / 140

- DISPOSABLE CONTAINER  
- GLOVE BOX  
- CONTENEDOR  
DESECHABLE  
- CAJA DE GUANTES

SEAL LOCKING  
BLOQUEO PARA  
PRECINTOS



**Q260 R**  
SQ161 R.12.14.28.32R.34.36.40

**EMERGENCY EMERGENCIA**  
**SQM SERIES SERIE CÉ**

~~ISO~~

**480 x 480 mm**



**EXTENSIVE MOBILITY TROLLEYS**  
**CARROS ALTA MOVILIDAD**

Security, manual locking  
 Numbered disposable seals

Seguridad, bloqueo manual  
 Precintos desechables numerados

SIMPLE WHEELS RUEDAS SIMPLES Ø 125 mm



SUCTION UNIT SUPPORT (Optional)  
 SOPORTE ASPIRADOR (Opcional)



**39**



**Q222 R**  
 SQ161 R.12.14.36.40  
 Primary care Atención primaria



**Q272 B**  
 SQ161 B.12.14.34.36.40



**Q299 R**  
 SQ161 R.12.14.28.32R.34.36.39.40



**Q224 R**  
 SQ161 R.12.14.26LW(R7Q).  
 28EV.32R.34.36.40

**BROSELOW PAEDIATRIC EMERGENCY**  
**EMERGENCIA PEDIÁTRICA BROSELOW**  
**100 SERIES SERIE CE**

**ISO**

**640 x 480 mm**

BROSELOW PAEDIATRIC TAPE (Optional)  
 CINTA PEDIÁTRICA BROSELOW (Opcional)



**TBR**

SERUM  
 SUEROS



600 x 400 mm ISO drawers  
**HBR** Broselow 9 colour card holder set  
 4 drawers divided into 2 equal parts  
 Cajones ISO 600 X 400 mm  
**HBR** Conjunto portatarjetas 9 colores Broselow  
 4 cajones divididos en 2 partes iguales



GAS BOTTLE  
 Ø 110 / 140  
 BOTELLA DE GAS  
 Ø 110 / 140

DRAWER WITHOUT DIVIDER

CAJÓN SIN SEPARADOR

EACH DRAWER LOCKING  
 WITH SEAL

BLOQUEO DE CADA  
 CAJÓN CON PRECINTO

AUXILIARY DRAWER  
 WITHOUT DIVIDER

CAJÓN AUXILIAR  
 SIN SEPARADOR

**1200 W**  
 164M6 W.HBR.12B.14.36.40.(4)DS10



**EMERGENCY EMERGENCIA  
100 SERIES SERIE CE**

**ISO  
640 x 480 mm**

**EXTENSIVE MOBILITY TROLLEYS  
CARROS ALTA MOVILIDAD**

DOUBLE WHEELS RUEDAS DOBLES Ø 125 mm



DIVIDERS (Optional)  
SEPARADORES (Opcional)



H5/16, (3)H10/4, H20/4

DEFIBRILLATOR  
2 ROTATION AXLES

DESFIBRILADOR  
2 EJES DE GIRO

SERUM  
SUEROS

CPR BOARD  
TABLA RCP

GAS BOTTLE  
Ø 110 / 140  
BOTELLA DE GAS  
Ø 110 / 140

- DISPOSABLE CONTAINER  
- GLOVE BOX

- CONTENEDOR  
DESECHABLE  
- CAJA DE GUANTES

SEAL LOCKING  
BLOQUEO PARA  
PRECINTOS



**1296 R**  
165 R.12.14.28.32R.34.36.40



**EMERGENCY EMERGENCIA  
100 SERIES SERIE CE**

**ISO  
640 x 480 mm**

**EXTENSIVE MOBILITY TROLLEYS  
CARROS ALTA MOVILIDAD**

DIVIDERS (Optional)  
SEPARADORES (Opcional)



**(2)H5/16, (3)H10/4, H20/4**

DEFIBRILLATOR  
2 ROTATION AXLES

DESFIBRILADOR  
2 EJES DE GIRO



- DISPOSABLE CONTAINER  
- GLOVE BOX

- CONTENEDOR  
DESECHABLE  
- CAJA DE GUANTES

SEAL LOCKING

BLOQUEO PARA  
PRECINTOS

SERUM

SUEROS

SYRINGES

JERINGUILLAS

GLOVE BOX

CAJA DE GUANTES

CPR BOARD

TABLA RCP

GAS BOTTLE

Ø 110 / 140

BOTELLA DE GAS

Ø 110 / 140



**1210 R**

162M6 R.12.14.26(RA5.A5.R1).28EV.32R.34.36.40

**EMERGENCY EMERGENCIA**  
**100 SERIES SERIE CE**

**ISO**  
**640 x 480 mm**



**EXTENSIVE MOBILITY TROLLEYS**  
**CARROS ALTA MOVILIDAD**

Security, manual locking. Numbered disposable seals  
 Seguridad, bloqueo manual. Precintos desechables numerados

SIMPLE WHEELS Ø 125 mm (Optional)  
 RUEDAS SIMPLES Ø 125 mm (Opcional)



**WS12**



**1270 R.AXWD12.WS12**  
 165 R.AXWD12.WS12.12.14.28.36.40  
 Primary care Atención primaria



**1272 B.AXWD12.WS12**  
 165 B.AXWD12.WS12.12.14.34.36.40



**1208 R**  
 162M6 R.12.14.28.32R.34.36.40



**1254 R**  
 165 R.12.14.32R.34.36.40.46



**1266 R**  
 165 R.12.14.28.34.36.40.44L



**1299 R**  
 165 R.12.14.28.32R.34.36.39.40



**1224 R**  
 165 R.12.14.26LW(R7).28EV.  
 32R.34.36.40

# TREATMENT CURAS





## TREATMENT CURAS



**TREATMENT CURAS  
SQM SERIES SERIE C€**

~~ISO~~  
**480 x 480 mm**

HOSPITALIZATION UNITS

UNIDADES DE HOSPITALIZACIÓN



**EXTENSIVE MOBILITY TROLLEYS**  
CARROS ALTA MOVILIDAD

**TREATMENT TROLLEY PREPARED FOR DIGITALIZATION**

CARRO DE CURAS PREPARADO PARA DIGITALIZACIÓN

COMPUTER

ORDENADOR

VESA SUPPORT  
3 POSITIONS,  
ADJUSTABLE

SOPORTE VESA  
3 POSICIONES,  
REGULABLE

- DISPOSABLE CONTAINER  
- ALCOHOL,  
CHLORHEXIDINE JARS

- CONTENEDOR  
DESECHABLE  
- BOTES ALCOHOL,  
CLORHEXIDINA

3 GLOVE BOX

3 CAJAS DE  
GUANTES

DIVIDERS (Optional)  
SEPARADORES (Opcional)



**4 DMQ, 8 DSQ**

FOLD  
DOWN TRAY

BANDEJA  
ABATIBLE

WASTE BIN

CUBO DESECHOS



**Q190 W**

SQ161TXQ W.26M(R75QM).30.32L.46.50



**TREATMENT CURAS  
SQM SERIES SERIE CÉ**

~~ISO~~  
**480 x 480 mm**

HOSPITALIZATION UNITS

UNIDADES DE HOSPITALIZACIÓN

SIMPLE WHEELS RUEDAS SIMPLES Ø 125 mm



**EXTENSIVE MOBILITY TROLLEYS  
CARROS ALTA MOVILIDAD**



**Q102 W**  
SQ122 W.32R.50



**Q105 B**  
SQ132 B.32R.50



**Q126 W**  
SQ161 W.32L.33R.50  
Phlebotomy Extracciones



**Q106 W**  
SQ161 W.32R.46.50



**Q108 W**  
SQ161 W.27.32R.46.50



**Q112 W**  
SQ161 W.32R.46.48L.50



**Q136 B**  
SQ161 B.26LW(R1Q).33R.46.50



**Q142 B**  
SQ161 B.30.32L.46.50



**Q158 W**  
SQ161 W.26(RA5Q.A5.R1Q).  
30.33L.46.50

**TREATMENT CURAS  
OPEN TROLLEY CARRO ABIERTO CE**

**ISO  
640 x 480 mm**

HOSPITALIZATION UNITS

UNIDADES DE HOSPITALIZACIÓN



**EXTENSIVE MOBILITY TROLLEYS  
CARROS ALTA MOVILIDAD**



Retention stop rails  
Guías con tope de retención

CENTRAL SUPPORT (Optional)  
SOPORTE CENTRAL (Opcional)



**26LW(R1)**

- DISPOSABLE CONTAINER  
- GLOVE BOX

- CONTENEDOR  
DESECHABLE  
- CAJA DE GUANTES



WASTE BIN  
CUBO DESECHOS

**165AB.32R.50AB**

**TREATMENT CURAS  
100 SERIES SERIE CE**

**ISO  
640 x 480 mm**

HOSPITALIZATION UNITS

UNIDADES DE HOSPITALIZACIÓN



**EXTENSIVE MOBILITY TROLLEYS  
CARROS ALTA MOVILIDAD**

DOUBLE WHEELS RUEDAS DOBLES Ø 125 mm



DIVIDERS (Optional)  
SEPARADORES (Opcional)



**H5/8, (3)H10/4, H20/4**

- DISPOSABLE CONTAINER  
- ALCOHOL,  
CHLORHEXIDINE JARS

- CONTENEDOR  
DESECHABLE  
- BOTES ALCOHOL,  
CLORHEXIDINA

3 GLOVE BOX

3 CAJAS DE  
GUANTES



WASTE BIN  
CUBO DESECHOS

**1606 B**  
165 B.32R.46.50

**TREATMENT CURAS  
100 SERIES SERIE CE**

**ISO  
640 x 480 mm**

HOSPITALIZATION UNITS

UNIDADES DE HOSPITALIZACIÓN



**EXTENSIVE MOBILITY TROLLEYS  
CARROS ALTA MOVILIDAD**

DIVIDERS (Optional)  
SEPARADORES (Opcional)



**H5/8, (3)H10/4, H20/4**

SYRINGES

JERINGUILLAS

ALCOHOL,  
CHLORHEXIDINE JARS

BOTES ALCOHOL, CLORHEXIDINA

DISPOSABLE  
CONTAINER

CONTENEDOR  
DESECHABLE



Contaminated waste  
on right side

Desechos contaminados  
en lado derecho

WASTE BIN

CUBO DESECHOS



3 GLOVE BOX

3 CAJAS DE  
GUANTES

**1638 W**

165 W.26(RA4.A5.R1).33R.46.50

**TREATMENT CURAS  
100 SERIES SERIE CE**

**ISO  
640 x 480 mm**

HOSPITALIZATION UNITS

UNIDADES DE HOSPITALIZACIÓN



**EXTENSIVE MOBILITY TROLLEYS**

**CARROS ALTA MOVILIDAD**

SIMPLE WHEELS Ø 125 mm (Optional)

RUEDAS SIMPLES Ø 125 mm (Opcional)



**WS12**



**1601 W.AXWD12.WS12**  
122 W. AXWD12.WS12.32R.50



**1602 G.AXWD12.WS12**  
133 G.AXWD12.WS12.32R.50



**1607 W**  
165 W.32R.33L.46.50



**1608 W**  
165 W.27.32R.46.50



**1672 B**  
165 B.26(RA4.A5).32R.46.50



**1625 B**  
165 B.32L.33R.46.50



**1636 G**  
165 G.26LW(R1).33R.46.50



**1642 B**  
165 B.30.32L.46.50



# UNIT DOSE MEDICATION MEDICACIÓN UNIDOSIS



# UNIT DOSE MEDICATION MEDICACIÓN UNIDOSIS





# TRANSPORT TROLLEYS WITH CASSETTES CARROS DE TRANSPORTE CON CASETES

**ISO  
640 x 480 mm**

## 600 SERIES SERIE

HOSPITAL PHARMACY

FARMACIA HOSPITALARIA

Handles, both sides

Key locking

C5, unit dose medication cassettes

600 x 400 mm ISO drawers

Ø 125 mm simple wheels

Asas, ambos lados

Bloqueo de llave

C5, casetes medicación unidosis

Cajones ISO 600 x 400 mm

Ruedas simples Ø 125 mm

Maximum 8 cassettes - 40 patients

Máximo 8 casetes - 40 pacientes

UPPER SUPPLEMENT (Optional)

SUPLEMENTO SUPERIOR (Opcional)



68

Maximum 10 cassettes - 50 patients

Máximo 10 casetes - 50 pacientes



608FAR.8MT.(6)C5.(2)72



610FAR.10MT.(10)C5

**TRANSPORT TROLLEYS WITH CASSETTES**  
**CARROS DE TRANSPORTE CON CASETES**

**ISO**  
**850 x 640 mm**

**600 SERIES SERIE**

**HOSPITAL PHARMACY**

**FARMACIA HOSPITALARIA**

Handles, both sides  
 Key locking, both sides  
 C5, unit dose medication cassettes  
 600 x 400 mm ISO drawers  
 Ø 150 mm double wheels  
 Maximum 8 + 8 = 16 cassettes - 80 patients

Asas, ambos lados  
 Bloqueo de llave, ambos lados  
 C5, casetes medicación unidosis  
 Cajones ISO 600 x 400 mm  
 Ruedas dobles Ø 150 mm  
 Máximo 8 + 8 = 16 casetes - 80 pacientes



UPPER SUPPLEMENT (Optional)  
 SUPLEMENTO SUPERIOR (Opcional)



**68B**

2 DUAL LOCK WHEELS  
 2 RUEDAS DOBLE BLOQUEO  
 4 antistatic 4 antiestáticas



-  Fixed wheel  
Rueda fija
-  Swivel wheel  
Rueda giratoria
-  Locked wheel  
Rueda bloqueada



**616FAR.(2)8MT.(16)C5**

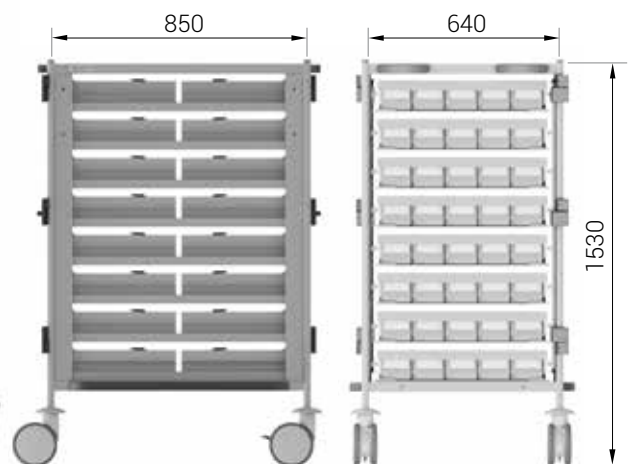

**UNIT DOSE MEDICATION MEDICACIÓN UNIDOSIS**  
**600 / 100 SERIES SERIE C€**

**ISO**

**INTERCHANGEABLE CASSETTE, 5 PATIENTS CASETE INTERCAMBIABLE, 5 PACIENTES**

Compatible with pharmacy ISO furniture  
 Polypropylene and aluminium, grey colour  
 Cassette lock, epoxy painted steel  
 Locked cassette, card upper part hidden, lower part visible  
 Cassette total weight 4,6 kg.

Compatible con el mobiliario ISO de la farmacia  
 Polipropileno y aluminio, color gris  
 Bloqueo casete, acero pintado epoxi  
 Casete bloqueado, parte superior de la tarjeta oculta, parte inferior visible  
 Peso total del casete 4,6 kg.

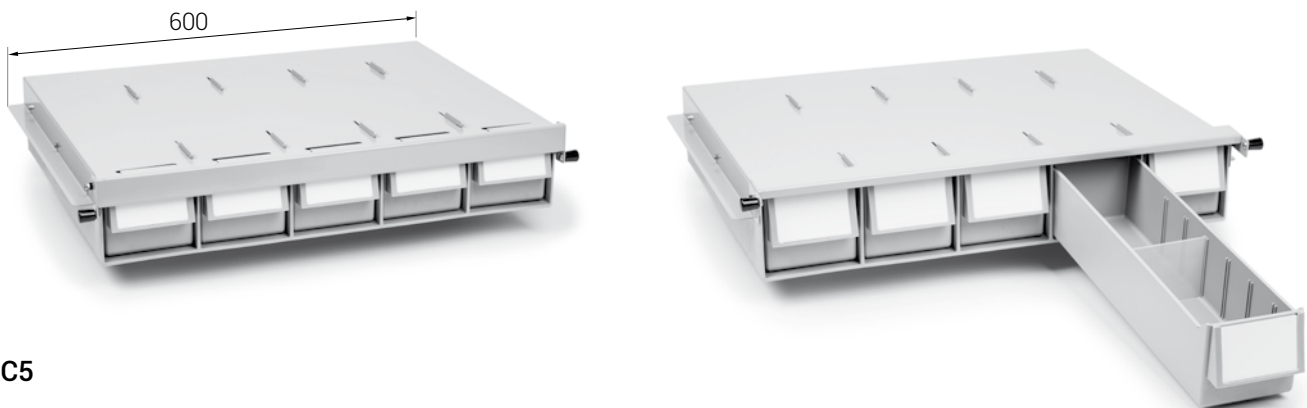

**C5**

**MEDICATION CONTAINER CONTENEDOR DE MEDICACIÓN**

Capacity: 3 litres  
 ISO norm 7810 identification card, international standard  
 Appropriate for intravenous therapy medication, re-packaged medication in unit doses, pills, prefilled syringes, syrups, etc

Capacidad: 3 litros  
 Tarjeta de identificación norma ISO 7810, estándar internacional  
 Adecuado para medicación de terapia intravenosa, medicación reenvasada en dosis unitarias, comprimidos, jeringas precargadas, jarabes, etc

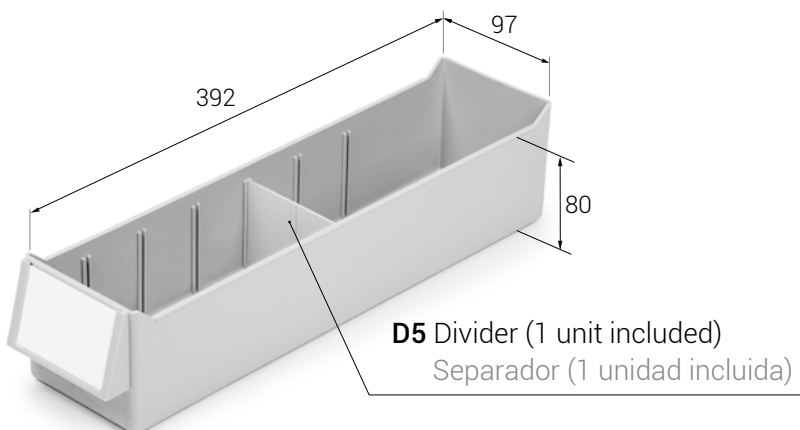



**UNIT DOSE MEDICATION MEDICACIÓN UNIDOSIS**  
**100 SERIES SERIE CÉ**

**ISO**  
**640 x 480 mm**

Key locking (included)

Bloqueo de llave (incluido)



**106M6**  
**106M6TX**

Keyboard drawer, cable lead through  
 Cajón para teclado, pasacables



**108M6**



**110M6**  
**110M6TX**

Keyboard drawer, cable lead through  
 Cajón para teclado, pasacables



**112M6**



**113M6**  
**113M6TX**

Keyboard drawer, cable lead through  
 Cajón para teclado, pasacables



**114M6**



**117M6**  
**117M6TX**

Keyboard drawer, cable lead through  
 Cajón para teclado, pasacables



**118M6**



**120M6**

**TREATMENT - MEDICATION CURAS - MEDICACIÓN**  
**100 SERIES SERIE CÉ**

**ISO**  
**640 x 480 mm**

HOSPITALIZATION UNITS

UNIDADES DE HOSPITALIZACIÓN

 **EXTENSIVE MOBILITY TROLLEYS**  
**CARROS ALTA MOVILIDAD**

A single health worker performs the treatment and administers the medication to the patient

Un único sanitario realiza las curas y administra la medicación al paciente

SYRINGES

JERINGUILLAS

ALCOHOL,  
 CHLORHEXIDINE  
 JARS

BOTES ALCOHOL,  
 CLORHEXIDINA

SERUM,  
 PARACETAMOL DRAWER

CAJÓN SUEROS,  
 PARACETAMOL

DIVIDERS (Optional)  
 SEPARADORES (Opcional)



**(2)H10/4, H20/4**

DISPOSABLE  
 CONTAINER

CONTENEDOR  
 DESECHABLE

KEY LOCKING

BLOQUEO DE LLAVE

REMOVABLE CASSETTE

CASETE EXTRAÍBLE

WASTE BIN

CUBO DESECHOS



Contaminated  
 waste on right side

Desechos  
 contaminados en  
 lado derecho



**1807 B**

108M6 B.26(RA4.A5).(2)32L.33R.50

**UNIT DOSE MEDICATION MEDICACIÓN UNIDOSIS**  
**100 SERIES SERIE CÉ**

**ISO**  
**640 x 480 mm**

HOSPITALIZATION UNITS

UNIDADES DE HOSPITALIZACIÓN



**EXTENSIVE MOBILITY TROLLEYS**  
**CARROS ALTA MOVILIDAD**

DIVIDERS (Optional)  
 SEPARADORES (Opcional)



**H10/4, H20/4**



COMMON MATERIAL  
 PATIENTS DRAWER

CAJÓN MATERIAL  
 COMÚN PACIENTES

3 GLOVE BOX

3 CAJAS DE  
 GUANTES

SERUM,  
 PARACETAMOL DRAWER

CAJÓN SUEROS,  
 PARACETAMOL

DISPOSABLE  
 CONTAINER

CONTENEDOR  
 DESECHABLE

KEY LOCKING

BLOQUEO DE LLAVE

REMOVABLE CASSETTE

CASETE EXTRAÍBLE

WASTE BIN

CUBO DESECHOS

**1809 W**  
 112M6 W.32R.46.50

**UNIT DOSE MEDICATION MEDICACIÓN UNIDOSIS  
100 SERIES SERIE CÉ**

**ISO  
640 x 480 mm**

**HOSPITALIZATION UNITS**

**UNIDADES DE HOSPITALIZACIÓN**

**UNIT DOSE MEDICATION TROLLEY PREPARED FOR DIGITALIZATION**

**CARRO DE MÉDICACIÓN UNIDOSIS PREPARADO PARA DIGITALIZACIÓN**

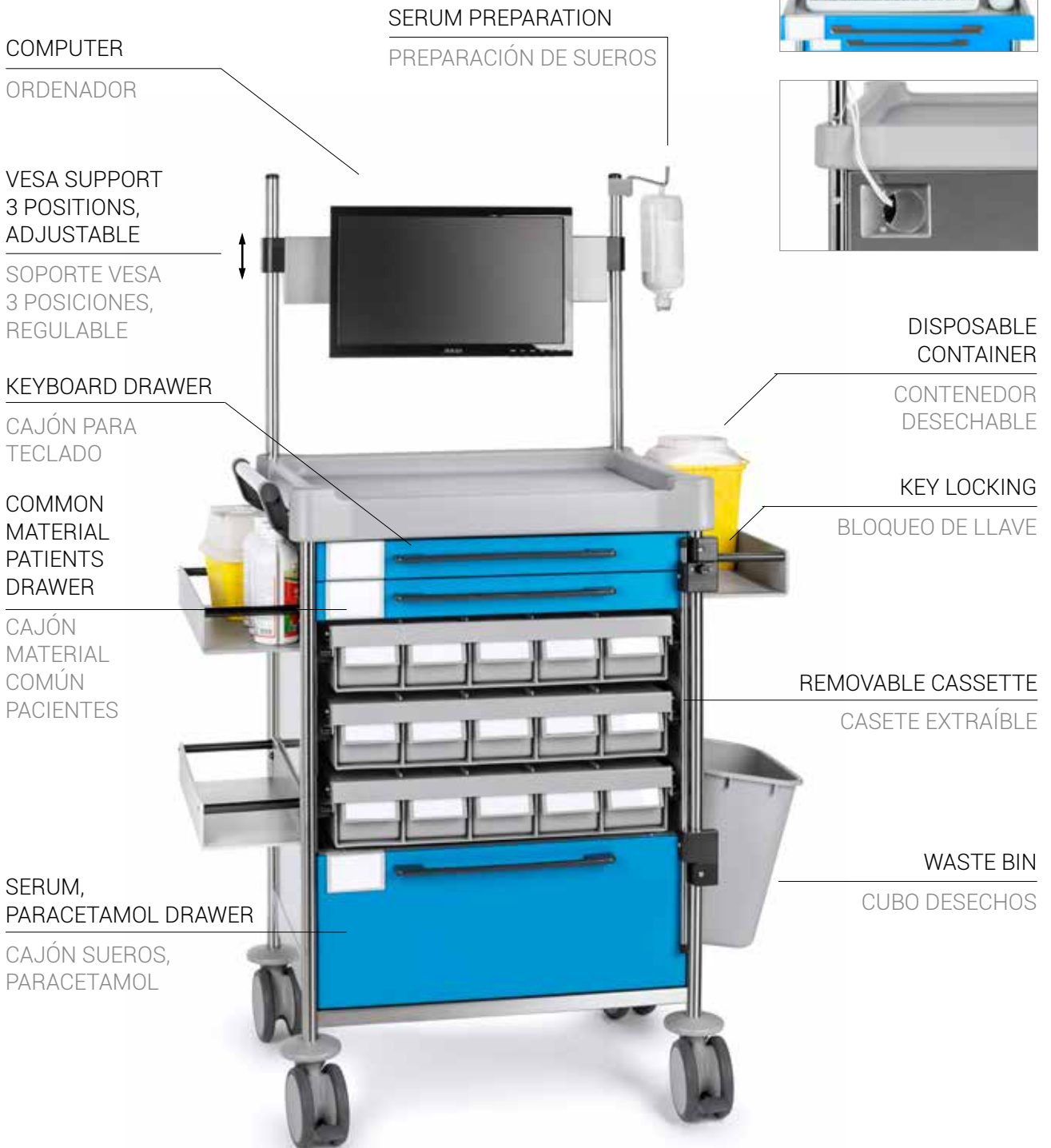

COMPUTER  
ORDENADOR

SERUM PREPARATION  
PREPARACIÓN DE SUEROS

VESA SUPPORT  
3 POSITIONS,  
ADJUSTABLE  
SOPORTE VESA  
3 POSICIONES,  
REGULABLE

KEYBOARD DRAWER  
CAJÓN PARA  
TECLADO

COMMON  
MATERIAL  
PATIENTS  
DRAWER

CAJÓN  
MATERIAL  
COMÚN  
PACIENTES

SERUM,  
PARACETAMOL DRAWER  
CAJÓN SUEROS,  
PARACETAMOL

DISPOSABLE  
CONTAINER

CONTENEDOR  
DESECHABLE

KEY LOCKING  
BLOQUEO DE LLAVE

REMOVABLE CASSETTE  
CASETE EXTRAÍBLE

WASTE BIN  
CUBO DESECHOS

**1891 B**

110M6TX B.26M(R75M).(2)32L.32R.50.58

**UNIT DOSE MEDICATION MEDICACIÓN UNIDOSIS**  
**100 SERIES SERIE CÉ**

**ISO**  
**640 x 480 mm**



**1808 W**  
 108M6 W.32R.46.50

Treatment - Medication  
 Curas - Medicación



**1817 W**  
 108M6 W.26(RA4.A5).27EV.  
 (2)32L.33R.50

Treatment - Medication  
 Curas - Medicación



**1813 Y**  
 112M6 Y.27.32R.46.50



**1818 Y**  
 112M6 Y.(2)32L.33R.50



**1894 B**  
 114M6 B.32R.46.50



**1890 W**  
 106M6TX W.26M(R75M).(2)32L.32R.50



**1892 B**  
 113M6TX B.26M(R75M).(2)32L.32R.50



**1893 B**  
 117M6TX B.26M(R75M).(2)32L.32R.50



**TRANSPORT TROLLEYS CARROS DE TRANSPORTE**  
**500 SERIES SERIE**



**EXTENSIVE MOBILITY TROLLEYS**  
**CARROS ALTA MOVILIDAD**

Structure of AISI-304 stainless steel  
 Assembly with TIG welding  
 Load capacity 120 kg  
 Ø 125 mm simple wheels  
 2 antistatic, 2 with brake

Estructura de acero inoxidable AISI-304  
 Ensamblaje con soldadura TIG  
 Capacidad de carga 120 kg  
 Ruedas simples Ø 125 mm  
 2 antiestáticas, 2 con freno



**SQ505**



**SQ510**

**480 x 480 mm**



**505**



**510**

**640 x 480 mm**



**520**



**530**



**540**

**900 x 570 mm**

# INSTRUMENT TRANSPORT TROLLEYS

## CARROS DE TRANSPORTE PARA INSTRUMENTAL

### 500 SERIES SERIE

**900 x 630 mm**

For 600 x 300 mm containers  
 Monobloc structure of AISI-304 stainless steel  
 Assembly with rivets and TIG welding  
 Load capacity 150 kg  
 Key locking  
 Non-airtight phenolic doors

Para contenedores de 600 x 300 mm  
 Estructura monobloque de acero inoxidable AISI-304  
 Ensamblaje con remaches y soldadura TIG  
 Capacidad de carga 150 kg  
 Bloqueo de llave  
 Puertas fenólico de cierre no hermético

UPPER SUPPLEMENT (Optional)  
 SUPLEMENTO SUPERIOR (Opcional)





**68B**



**567 DN**

2 DUAL LOCK WHEELS  
 Ø 125 mm  
 2 RUEDAS DOBLE BLOQUEO  
 Ø 125 mm

 Fixed wheel  
 Rueda fija

 Swivel wheel  
 Rueda giratoria

 Locked wheel  
 Rueda bloqueada



**566 DN** Trolley with 2 smooth central shelves  
 Carro con 2 estantes centrales lisos

**567 DN** Trolley with 2 perforated central shelves for ventilation  
 Carro con 2 estantes centrales perforados para ventilación

**TRANSPORT TROLLEYS CARROS DE TRANSPORTE**  
**600 SERIES SERIE**

**ISO**  
**640 x 480 mm**

Monobloc structure of AISI-304 stainless steel  
 Assembly with rivets and TIG welding  
 Doors with key locking  
 600 x 400 mm ISO drawers  
 Maximum capacity 10 ISO drawers 100 mm height

Estructura monobloque de acero inoxidable AISI-304  
 Ensamblaje con remaches y soldadura TIG  
 Puertas con bloqueo de llave  
 Cajones ISO 600 x 400 mm  
 Capacidad máxima 10 cajones ISO altura 100 mm

**DN** Light grey doors Puertas gris claro  
**TT** Transparent doors Puertas transparentes



**606 DN.(6)72.(2)73**

UPPER SUPPLEMENT (Optional)  
 SUPLEMENTO SUPERIOR (Opcional)



**68**

ADJUSTABLE SHELF (Optional)  
 BANDEJA REGULABLE (Opcional)



**60 - 600 x 440 mm**



RETENTION STOP (Optional)  
 TOPE DE RETENCIÓN (Opcional)  
 1 set per drawer 1 juego por cajón



**TR**

2 DUAL LOCK WHEELS Ø 125 mm  
 2 RUEDAS DOBLE BLOQUEO Ø 125 mm



-  Fixed wheel  
Rueda fija
-  Swivel wheel  
Rueda giratoria
-  Locked wheel  
Rueda bloqueada

**TRANSPORT TROLLEYS CARROS DE TRANSPORTE  
600 SERIES SERIE**

**ISO  
640 x 480 mm**



606 OP.(8)72.73



606 DN.(3)60



606 DN.(2)60.(4)72.73



606 DN.(8)72.73



631 DN.(2)60



632 DN.(2)60



651 DN



652 DN



657 DN

1655



**TRANSPORT TROLLEYS CARROS DE TRANSPORTE**  
**600 SERIES SERIE**

**ISO**  
**900 x 630 mm**

Monobloc structure of AISI-304 stainless steel  
 Assembly with rivets and TIG welding  
 Load capacity 160 kg  
 Doors with key locking  
 400 x 600 mm ISO drawers  
 Maximum capacity 10 + 10 = 20 ISO drawers 100 mm height

Estructura monobloque de acero inoxidable AISI-304  
 Ensamblaje con remaches y soldadura TIG  
 Capacidad de carga 160 kg  
 Puertas con bloqueo de llave  
 Cajones ISO 400 x 600 mm  
 Capacidad máxima 10 + 10 = 20 cajones ISO altura 100 mm

**DN** Light grey doors Puertas gris claro  
**TT** Transparent doors Puertas transparentes

UPPER SUPPLEMENT (Optional)  
 SUPLEMENTO SUPERIOR (Opcional)



**68B**

ADJUSTABLE SHELF (Optional)  
 BANDEJA REGULABLE (Opcional)



**62 - 400 x 600 mm**



RETENTION STOP (Optional)  
 TOPE DE RETENCIÓN (Opcional)  
 1 set per drawer 1 juego por cajón



**TR**

2 DUAL LOCK WHEELS Ø 150 mm  
 2 RUEDAS DOBLE BLOQUEO Ø 150 mm  
 4 antistatic 4 antiestáticas



-  Fixed wheel  
Rueda fija
-  Swivel wheel  
Rueda giratoria
-  Locked wheel  
Rueda bloqueada



**620 DN.(12)72.(4)73**

## TRANSPORT TROLLEYS CARROS DE TRANSPORTE 600 SERIES SERIE

Monobloc structure of AISI-304 stainless steel  
 Assembly with rivets and TIG welding  
 Handles, both sides  
 600 x 400 mm ISO drawers  
 Ø 125 mm simple wheels

Estructura monobloque de acero inoxidable AISI-304  
 Ensamblaje con remaches y soldadura TIG  
 Asas, ambos lados  
 Cajones ISO 600 x 400 mm  
 Ruedas simples Ø 125 mm

### ISO 640 x 480 mm

Load capacity 100 kg  
 Maximum 10 ISO drawers 100 mm height



Capacidad de carga 100 kg  
 Máximo 10 cajones ISO altura 100 mm



610TRT.(8)72.73

2 DUAL LOCK WHEELS (Optional)  
 2 RUEDAS DOBLE BLOQUEO (Opcional)



-  Fixed wheel  
Rueda fija
-  Swivel wheel  
Rueda giratoria
-  Locked wheel  
Rueda bloqueada

WDD12 - Ø 125 mm - Mod. 610TRT

WDD15 - Ø 150 mm - Mod. 620TRT

### ISO 880 x 680 mm

Load capacity 160 kg  
 Maximum 20 ISO drawers 100 mm height

Capacidad de carga 160 kg  
 Máximo 20 cajones ISO altura 100 mm



620TRT.(16)72.(2)73

**SQUARE TROLLEYS CARROS CUADRADOS**  
**SQS SERIES SERIE C€**

~~ISO~~  
**480 x 480 mm**



**STATIC TROLLEYS**  
**CARROS ESTÁTICOS**



**SQ010**



**SQ005**



**SQ040**



**SQ021**

**SQ021TXQ**

Keyboard drawer, cable  
lead through

Cajón para teclado, pasacables



**SQ022**



**SQ032**



**SQ033**



**SQ061**

**SQ061TXQ**

Keyboard drawer, cable  
lead through

Cajón para teclado, pasacables



**SQ065**

**OPEN TROLLEYS CARROS ABIERTOS CE**

**ISO  
640 x 480 mm**



**STATIC TROLLEYS  
CARROS ESTÁTICOS**

- The work surface design allows you to move the trolley without needing the push handle
- Ø 100 mm wheels, 2 antistatic, 2 with brake
- El diseño de la superficie de trabajo permite manejar el carro sin necesidad de tirador
- Ruedas Ø 100 mm, 2 antiestáticas, 2 con freno



**322AB**



**364AB**



**365AB**



**EXTENSIVE MOBILITY TROLLEYS  
CARROS ALTA MOVILIDAD**

- Elevated push handle left side
- Bumpers for hits
- Ø 125 mm simple wheels, 2 antistatic, 2 with brake
- Tirador elevado lado izquierdo
- Protectores paragolpes
- Ruedas simples Ø 125 mm, 2 antiestáticas, 2 con freno



**164AB**



**165AB**



**166AB**

**SIMPLE TROLLEYS CARROS SIMPLES**  
**300 SERIES SERIE CÉ**

**ISO**  
**640 x 480 mm**

 **STATIC TROLLEYS**  
**CARROS ESTÁTICOS**



**310**



**305**  
**305MRI**



**321**  
**321MRI**  
**321TX**  
 Keyboard drawer, cable  
 lead through  
 Cajón para teclado, pasacables



**322**  
**322MRI**



**332**  
**332TX**  
 Keyboard drawer, cable  
 lead through  
 Cajón para teclado, pasacables



**333**



**334**



**341**



**346**



**SIMPLE TROLLEYS CARROS SIMPLES**  
**300 SERIES SERIE CÉ**

**ISO**  
**640 x 480 mm**



**STATIC TROLLEYS**  
**CARROS ESTÁTICOS**

**M6** Structure for 6 100 mm ISO drawers

**M6** Estructura para 6 cajones ISO 100 mm



**364**  
**364MRI**



**365**  
**365MRI**



**366**  
**366MRI**



**361M6**



**362M6**  
**362M6TX**  
 Keyboard drawer, cable  
 lead through  
 Cajón para teclado, pasacables



**364M6**



**365M6**



**366M6**



**367M6**

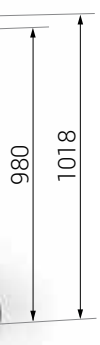

**DOUBLE TROLLEYS CARROS DOBLES**  
**300 SERIES SERIE** **CE**

**ISO**  
**900 x 630 mm**

 **STATIC TROLLEYS**  
**CARROS ESTÁTICOS**



**396LW**  
**900 x 570 mm**  
 Instrument table  
 Mesa de instrumental



**398LW**  
**1130 x 570 mm**  
 Instrument table  
 Mesa de instrumental



**N310**



**N305**



**N321**



**N322**



**N364**



**N365**



**N366**

**DOUBLE TROLLEYS CARROS DOBLES**  
**300 SERIES SERIE CÉ**

**ISO**  
**900 x 630 mm**



**STATIC TROLLEYS**  
**CARROS ESTÁTICOS**

**M12** Structure for 12 100 mm ISO drawers

M12 Estructura para 12 cajones ISO 100 mm



**N361M12**



**N362M12**



**N364M12**



**N365M12**



**N366M12**



**N367M12**

**LOW TROLLEYS, REDUCED HEIGHT**  
**CARROS BAJOS, ALTURA REDUCIDA** 

**LOW SQUARE TROLLEYS** **CARROS CUADRADOS BAJOS**

~~ISO~~

**480 x 480 mm**



**STATIC TROLLEYS**  
**CARROS ESTÁTICOS**



**SQ022LW**



**SQ061M4LW**

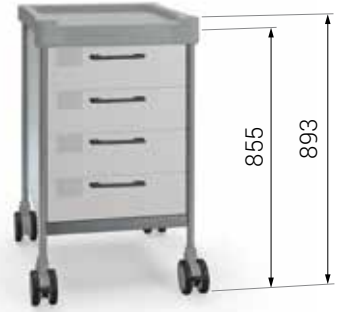

**SQ064M4LW**

**LOW SIMPLE TROLLEYS** **CARROS SIMPLES BAJOS**

**ISO**

**640 x 480 mm**



**STATIC TROLLEYS**  
**CARROS ESTÁTICOS**

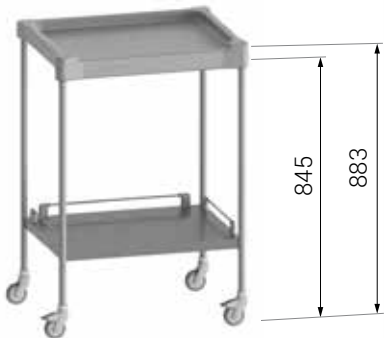

**310LW**

Ø 75 mm simple wheels  
 Ruedas simples Ø 75 mm



**361M5LW**



**362M5LW**



**364M5LW**



**365M5LW**



**366M5LW**

To store it under 900 mm work tables  
For users working in sitting position

Para guardarlos debajo de mesas de trabajo de 900 mm  
Para el usuario que trabaja en posición sentada

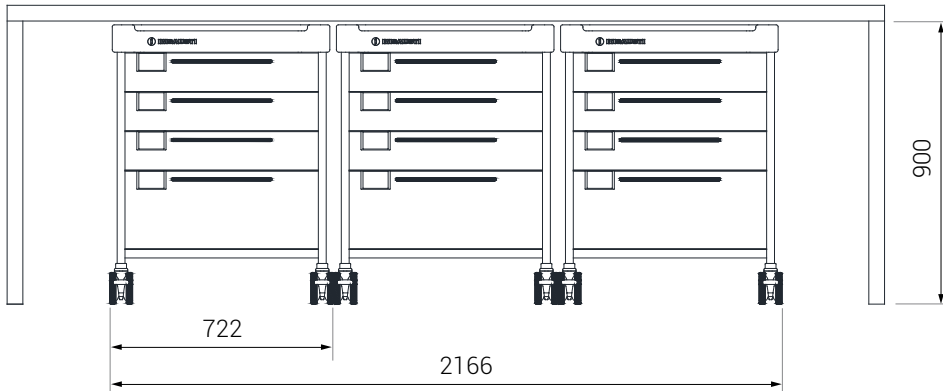

**LOW DOUBLE TROLLEYS CARROS DOBLES BAJOS**

**ISO  
900 x 630 mm**

 **STATIC TROLLEYS**  
**CARROS ESTÁTICOS**



**N361M10LW**



**N362M10LW**



**N364M10LW**



**N365M10LW**



**N366M10LW**



**SQUARE TROLLEYS CARROS CUADRADOS**  
**SQM SERIES SERIE C€**

~~ISO~~  
**480 x 480 mm**

 **EXTENSIVE MOBILITY TROLLEYS**  
**CARROS ALTA MOVILIDAD**

SIMPLE WHEELS RUEDAS SIMPLAS Ø 125 mm



**SQ121**  
**SQ121TXQ**

Keyboard drawer, cable  
lead through  
Cajón para teclado, pasacables



**SQ122**



**SQ132**



**SQ133**



**SQ161**  
**SQ161TXQ**

Keyboard drawer, cable  
lead through  
Cajón para teclado, pasacables



**SQ165**

**SIMPLE TROLLEYS CARROS SIMPLES**  
**100 SERIES SERIE CÉ**

**ISO**  
**640 x 480 mm**



**EXTENSIVE MOBILITY TROLLEYS**  
**CARROS ALTA MOVILIDAD**

**M6 Structure for 6 100 mm ISO drawers**

**M6 Estructura para 6 cajones ISO 100 mm**



**122 W.AXWD12.WS12**  
 Ø 125 mm simple wheels  
 Ruedas simples Ø 125 mm



**133 W.AXWD12.WS12**  
 Ø 125 mm simple wheels  
 Ruedas simples Ø 125 mm



**164**



**165**



**166**



**162M6**  
**162M6TX**  
 Keyboard drawer, cable lead through  
 Cajón para teclado, pasacables



**164M6**



**165M6**



**166M6**

## ACCESSORIES ACCESORIOS

### SQUARE TROLLEY DIVIDERS SEPARADORES CARRO CUADRADO

PC, polycarbonate PC, policarbonato

#### DMQ - Height Altura 57 mm



#### DSQ - Height Altura 130 mm

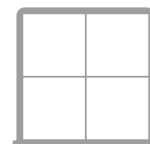
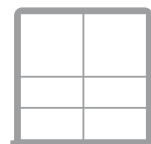
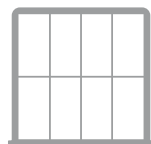
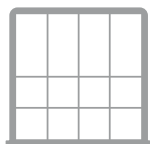
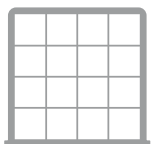

## ACCESSORIES ACCESORIOS

### ISO DRAWER DIVIDER SET CONJUNTO SEPARADORES CAJONES ISO

Dividers for 600 x 400 mm ISO drawers  
PC, polycarbonate

Separadores para cajones ISO 600 x 400 mm  
PC, policarbonato

Drawer Cajón 50 mm  
**DL5, DS5**

Drawer Cajón 100 mm  
**DL10, DS10**

Drawer Cajón 200 mm  
**DL20, DS20**

**DS5** 400 mm  
**DL5** 600 mm

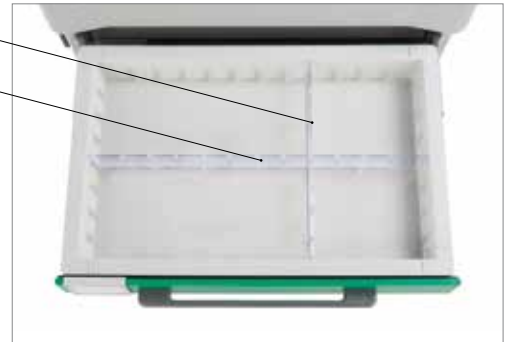

CLIP FOR DIVIDERS  
CLIP PARA SEPARADORES



**DT**



**H5/16**

ISO drawer Cajón ISO 50 mm

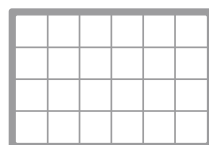

**H5/24**

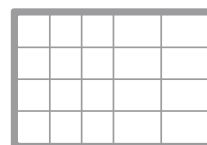

**H5/20**

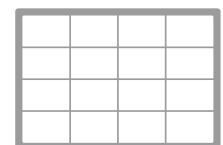

**H5/16**

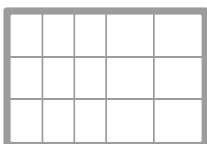

**H5/15**

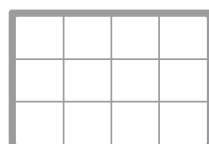

**H5/12, H10/12**

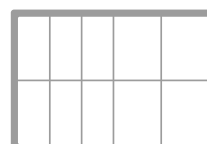

**H5/10, H10/10**

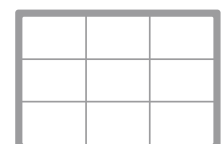

**H5/9, H10/9, H20/9**

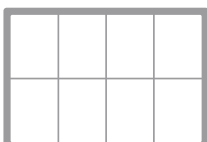

**H5/8, H10/8, H20/8**

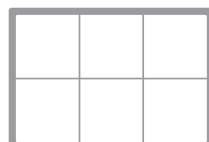

**H5/6, H10/6, H20/6**

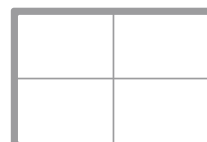

**H10/4, H20/4**

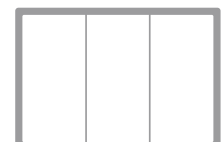

**H10/3, H20/3**

## ACCESSORIES ACCESORIOS

### KEY LOCKING BLOQUEO DE LLAVE



**10** Square, simple trolley, total locking  
Carro cuadrado, simple, bloqueo total

**10N2** Double trolley, total locking  
Left side, right side  
Carro doble, bloqueo total  
Lado izquierdo, lado derecho



**10D** Square trolley, 2 57 mm drawers locking  
Simple trolley, 2 50/100 mm ISO drawers locking  
Carro cuadrado, bloqueo 2 cajones 57 mm  
Carro simple, bloqueo 2 cajones ISO 50/100 mm

**10DN2** Double trolley, 4 ISO drawers locking  
50/100 mm left side, 50/100 mm right side  
Carro doble, bloqueo 4 cajones ISO  
2 lado izquierdo 50/100 mm, 2 lado derecho 50/100 mm



**10M2** Square trolley, 2 130 mm drawers locking  
Simple trolley, 2 100 mm ISO drawers locking  
Carro cuadrado, bloqueo 2 cajones 130 mm  
Carro simple, bloqueo 2 cajones ISO 100 mm

**10JK** Set of 4 keys  
Juego de 4 llaves

All the locks include 4 keys Todos los bloqueos incluyen 4 llaves

### CODE LOCKING BLOQUEO DE CÓDIGO



**10COD**  
Square, simple trolley, total locking  
Carro cuadrado, simple, bloqueo total

**10CODN2**  
Double trolley, total locking  
Left side, right side  
Carro doble, bloqueo total  
Lado izquierdo, lado derecho

**10CK**  
Security key for code locking  
Llave de seguridad para bloqueo de código

The lock includes 1 key El bloqueo incluye 1 llave



## ACCESSORIES ACCESORIOS

### SEAL LOCKING BLOQUEO PARA PRECINTOS



**12** Square, simple trolley, total locking  
Carro cuadrado, simple, bloqueo total

**12N2** Double trolley, total locking  
Left side, right side  
Carro doble, bloqueo total  
Lado izquierdo, lado derecho



**12D** Square trolley, 2 57 mm drawers locking  
Simple trolley, 2 50/100 mm ISO drawers locking  
Carro cuadrado, bloqueo 2 cajones 57 mm  
Carro simple, bloqueo 2 cajones ISO 50/100 mm

**12DN2** Double trolley, 4 ISO drawers locking  
50/100 mm left side, 50/100 mm right side  
Carro doble, bloqueo 4 cajones ISO  
2 lado izquierdo 50/100 mm, 2 lado derecho 50/100 mm

### INDIVIDUAL SEAL LOCKING BLOQUEO INDIVIDUAL PARA PRECINTOS



**12B** Square, simple trolley, maximum 11 seals  
Carro cuadrado, simple, máximo 11 precintos

**12BN2** Double trolley, maximum 22 seals  
11 left side, 11 right side  
Carro doble, máximo 22 precintos  
11 lado izquierdo, 11 lado derecho

### NUMBERED DISPOSABLE SEALS PRECINTOS DESECHABLES NUMERADOS



**14** Number for the control of hospital emergencies  
100 units

Numeración para el control de emergencias  
hospitalarias  
100 unidades

## RIGHT SIDE ACCESSORIES ACCESORIOS LADO DERECHO

### FOLD DOWN TRAY BANDEJA ABATIBLE

Polyethylene Polietileno  
Protection on all 4 sides Protección 4 lados  
Trolley Carro 480 x 480 mm  
640 x 480 mm



30

### SUCTION UNIT SUPPORT SOPORTE ASPIRADOR

Useful dimensions Dimensiones útiles 250 x 420 mm  
Max. 12 kg  
Epoxy painted steel Acero pintado epoxi



39

### 13 LITRES BIN CUBO 13 LITROS



50

### TWO 13 LITRES BINS DOS CUBOS 13 LITROS



50B

### 26 LITRES BIN CUBO 26 LITROS



51

### 25 LITRES PEDAL BIN CUBO DE PEDAL 25 LITROS



57

## LEFT SIDE ACCESSORIES ACCESORIOS LADO IZQUIERDO

### 3 GLOVE BOX HOLDER SOPORTE 3 CAJAS DE GUANTES

Depth Profundidad 87 mm  
Adjustable width Anchura regulable 200 - 260 mm



**46**  
460P Open trolley Carro abierto

### GAS BOTTLE STAND SOPORTE PARA BOTELLAS DE GAS

Ø 110 mm / Ø 140 mm. Max. 18 kg  
Supported with ref. 44L, 46, 59L  
Compatible con ref. 44L, 46, 59L



**36**

## LEFT - RIGHT SIDE ACCESSORIES ACCESORIOS LADO IZQUIERDO - DERECHO

### CATHETER CONTAINER CONTENEDOR DE CATÉTERES

Height Altura 420 mm  
Not supported with No compatible con ref. 30, 46



**44L** Left Izquierdo  
**44R** Right Derecho  
**D44** Divider Separador

### A4 DOCUMENT HOLDER PORTADOCUMENTOS A4

Height Altura 240 mm  
Dimensions Dimensiones 235 x 55 mm



**59L** Left Izquierdo  
**59R** Right Derecho

## LEFT - RIGHT SIDE ACCESSORIES

### ACCESORIOS LADO IZQUIERDO - DERECHO

#### DISPOSABLE CONTAINER SUPPORT APOYO CONTENEDOR DESECHABLE

Max. 10 litres 10 litros

Epoxy painted steel Acero pintado epoxi

↑ Variable height, bridle attachment  
↓ Altura variable, fijación con brida



**33L** Left Izquierdo

**33R** Right Derecho

#### SIDE SUPPORT SOPORTE LATERAL

Width Anchura 155 mm



Square, simple trolley Carro cuadrado, simple

**32L** Left Izquierdo

**32R** Right Derecho

Double trolley Carro doble

**32NL** Left Izquierdo

**32NR** Right Derecho

#### FIXING RAIL RIEL DE FIJACIÓN

25 x 10 mm Max. 20 kg

Stainless steel Acero inoxidable



Square, simple trolley Carro cuadrado, simple

**37L** Left Izquierdo

**37R** Right Derecho

Double trolley Carro doble

**37NL** Left Izquierdo

**37NR** Right Derecho

**BACK SIDE ACCESSORIES ACCESORIOS PARTE POSTERIOR**

**BACK FIXING RAIL  
RIEL DE FIJACIÓN POSTERIOR**

☒ 25 x 10 mm Max. 20 kg  
Stainless steel Acero inoxidable



**37QT** Square Cuadrado  
**37T** Simple

**CPR BOARD  
TABLA RCP  
(REANIMACIÓN CARDIOPULMONAR)**



Dimensions Dimensiones 660 x 440 mm



34

**ELECTRICAL CONNECTION BASE  
BASE DE CONEXIÓN ELÉCTRICA**



3 metres cable Cable 3 metros  
Integrated cable support Recogecables integrado



**38EU** SCHUKO, type F Tipo F  
**38US** USA, type B Tipo B  
**38UK** UK, type G Tipo G  
**38CH** Switzerland, type J Suiza, tipo J



## ACCESSORIES ACCESORIOS

### GLASS DISPENSER DISPENSADOR DE VASOS

For glasses of Para vasos de 150, 200, 220 ml  
Max. 70 glasses 70 vasos



- 47L Left Izquierdo
- 47R Right Derecho
- 47 Left side assembly in elevated accesory  
Montaje lado izquierdo en accesorio elevado

### HANGER SUPPORT SOPORTE COLGADOR

Max. 6 kg



58

### SERUM HOLDER PORTASUEROS



Stainless steel Acero inoxidable  
Max. 4 kg  
Adjustable height Altura regulable



40

### ELEVATED HANGER SUPPORT SOPORTE COLGADOR ELEVADO



Stainless steel Acero inoxidable  
Max. 4 kg  
For serum preparation Para preparación de sueros



41

**ACCESSORIES ACCESORIOS**

**GEL DISPENSER  
DISPENSADOR DE GEL**

500 ml rechargeable jar  
Bote recargable 500 ml



**48L** Left Izquierdo  
**48R** Right Derecho

**DRIP TRAY  
BANDEJA DE GOTEO**

Manually removable  
Desmontable manualmente



**GT**



**48Q** Square trolley Carro cuadrado  
Assembly Montaje en RA5Q, RA4Q



**48** Right side assembly in elevated accessory  
Montaje lado derecho en accesorio elevado

## ACCESSORIES ACCESORIOS

### ROTATING ARM FOR DEFIBRILLATOR BRAZO GIRATORIO PARA DESFIBRILADOR

Right side assembly  
Two rotation axles  
Fixing strap

Montaje lado derecho  
Dos ejes de giro  
Correa de fijación

Useful dimensions Dimensiones útiles 350 x 350 mm  
Max. 10 kg



**28**



**28EV** Assembly in elevated accessory  
Montaje en accesorio elevado

### LAPTOP BASE BASE PARA ORDENADOR PORTÁTIL

Left side assembly  
Rotating and tilting base  
Padlock with security cable

Montaje lado izquierdo  
Base giratoria y basculante  
Candado con cable de fijación

Width Anchura 398 - 308 mm Depth Profundidad 270 mm



**27**



**27EV** Assembly in elevated accessory  
Montaje en accesorio elevado

## ACCESSORIES ACCESORIOS

### TABLET SUPPORT SOPORTE PARA TABLETA

Variable height Altura variable  
 Width Anchura 195 - 300 mm  
 Tablets from 7" to 11" Tabletas desde 7" a 11"  
 Anti-theft system with key Sistema antirrobo con llave  
 Sistema antirrobo con llave



- 63L** Left Izquierdo
- 63R** Right Derecho
- 63** Assembly in elevated accessory Montaje en accesorio elevado

### MONITOR SUPPORT SOPORTE PARA MONITOR

3 Positions, height adjustable  
 Tilt and rotation adjustable  
 Epoxy painted steel

3 Posiciones, regulable en altura  
 Regulable en inclinación y giro  
 Acero pintado epoxi  
 VESA 75 / 100 mm



- 26M(R75QM)** Square Cuadrado
- 26M(R75M)** Simple

**ELEVATED ACCESSORIES ACCESORIOS ELEVADOS**

**ELEVATED TUBE SET  
JUEGO TUBOS ELEVADOS**

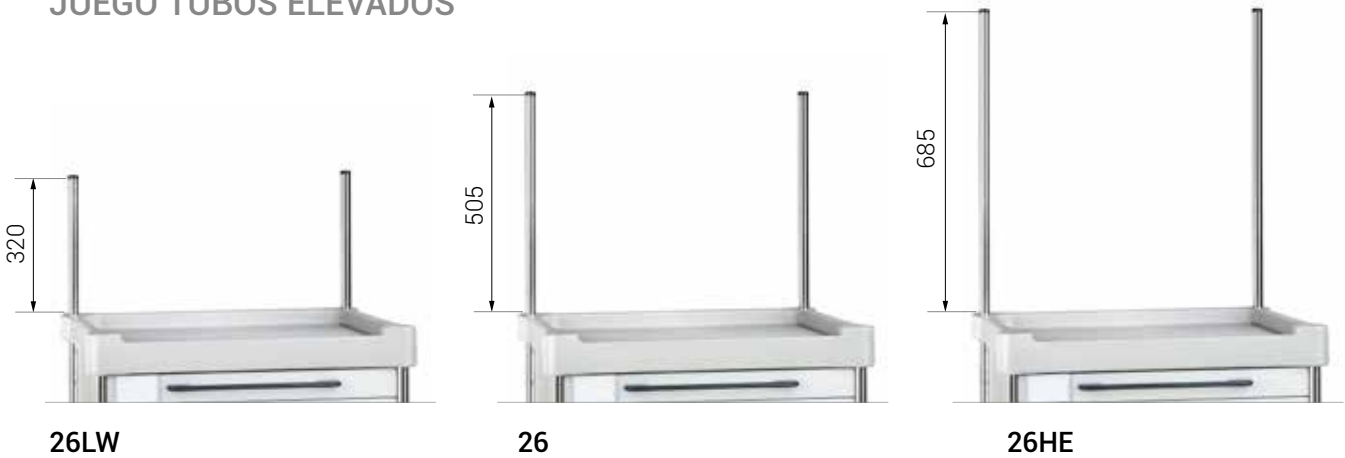

**26LW**

**26**

**26HE**



**BINS DISPENSER  
DISPENSADOR DE CAJITAS**



**RA3FQ.A5F** Square Cuadrado  
**RA3F.A5F** Simple

**RA5Q** Square Cuadrado  
**RA5** Simple  
**RA5N** Double Doble

**RA4Q** Square Cuadrado  
**RA4** Simple  
**RA4N** Double Doble

**FIFO**

**CENTRAL SUPPORT  
SOPORTE CENTRAL**

Epoxy painted steel  
Acero pintado epoxi  
Depth Profundidad 150 mm  
Max. 22 kg

**CENTRAL SHELF  
ESTANTE CENTRAL**

Epoxy painted steel  
Acero pintado epoxi  
Depth Profundidad 230 mm  
Max. 22 kg

**CENTRAL RAIL  
RIEL CENTRAL**

Stainless steel Acero inoxidable  
25 x 10 mm  
Max. 15 kg



**R1Q** Square Cuadrado  
**R1** Simple  
**R1N** Double Doble

**R2Q** Square Cuadrado  
**R2** Simple  
**R2N** Double Doble

**R7Q** Square Cuadrado  
**R7** Simple  
**R7N** Double Doble



**ELEVATED ACCESSORIES ACCESORIOS ELEVADOS**

**480 x 480 mm**  
**640 x 480 mm**  
**900 x 630 mm**

↑ Variable height, bridles attachment  
 ↓ Altura variable, fijación con bridas



**26LW(R1Q)** Square Cuadrado  
**26LW(R1)** Simple  
**26LW(R1N)** Double Doble



**26LW(R2Q)** Square Cuadrado  
**26LW(R2)** Simple  
**26LW(R2N)** Double Doble



**26LW(R7Q)** Square Cuadrado  
**26LW(R7)** Simple  
**26LW(R7N)** Double Doble



**26(R7Q)** Square Cuadrado  
**26(R7)** Simple  
**26(R7N)** Double Doble



**26(R1Q.R1Q)** Square Cuadrado  
**26(R1.R1)** Simple  
**26(R1N.R1N)** Double Doble



**26(R2Q.R2Q)** Square Cuadrado  
**26(R2.R2)** Simple  
**26(R2N.R2N)** Double Doble



**26(R7Q.R7Q)** Square Cuadrado  
**26(R7.R7)** Simple  
**26(R7N.R7N)** Double Doble



**26(R2Q.R1Q)** Square Cuadrado  
**26(R2.R1)** Simple  
**26(R2N.R1N)** Double Doble



**26(R2Q.R7Q)** Square Cuadrado  
**26(R2.R7)** Simple  
**26(R2N.R7N)** Double Doble

**ELEVATED ACCESSORIES ACCESORIOS ELEVADOS**

**480 x 480 mm  
640 x 480 mm**

↑ Variable height, bridles attachment  
↓ Altura variable, fijación con bridas

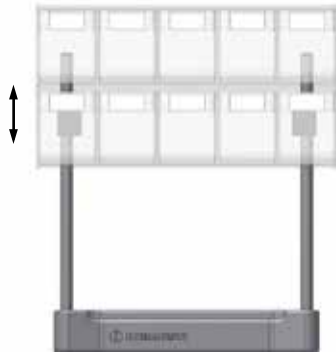

**26(RA5Q.A5)** Square Cuadrado  
**26(RA4Q.A5)** Square Cuadrado

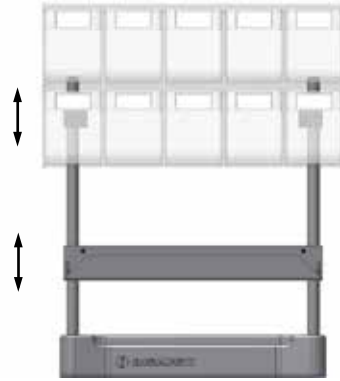

**26(RA5Q.A5.R1Q)** Square Cuadrado  
**26(RA4Q.A5.R1Q)** Square Cuadrado



**26(RA5Q.A5.R2Q)** Square Cuadrado  
**26(RA4Q.A5.R2Q)** Square Cuadrado



**26(RA5.A5)** Simple

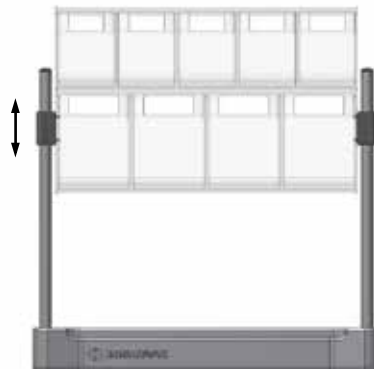

**26(RA4.A5)** Simple

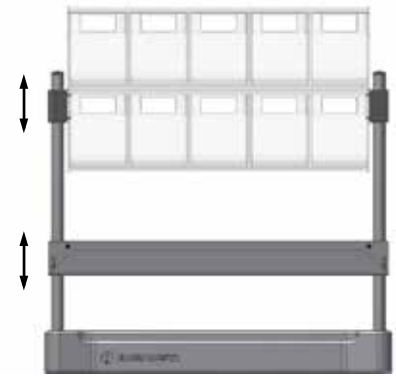

**26(RA5.A5.R1)** Simple



**26(RA4.A5.R1)** Simple



**26(RA5.A5.R2)** Simple



**26(RA4.A5.R2)** Simple

**ELEVATED ACCESSORIES ACCESORIOS ELEVADOS**

**900 x 630 mm**

↑ Variable height, bridles attachment  
 ↓ Altura variable, fijación con bridas

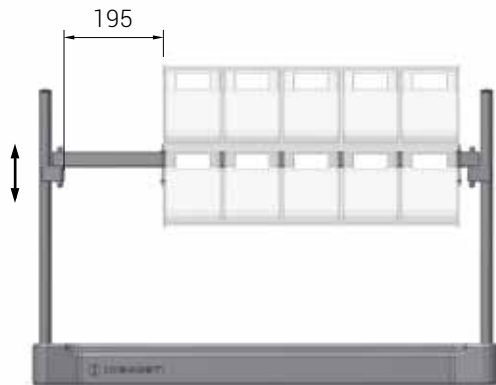

**26(RA5N.A5) Double Doble**

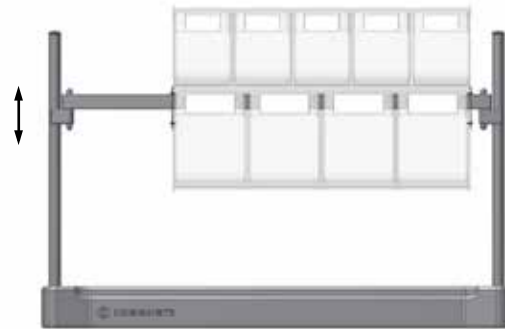

**26(RA4N.A5) Double Doble**

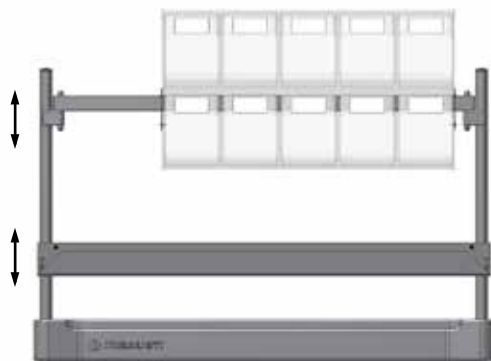

**26(RA5N.A5.R1N) Double Doble**

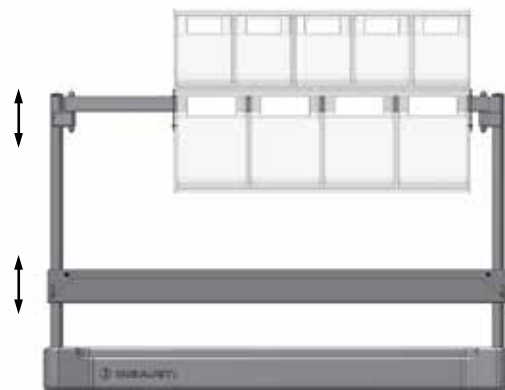

**26(RA4N.A5.R1N) Double Doble**

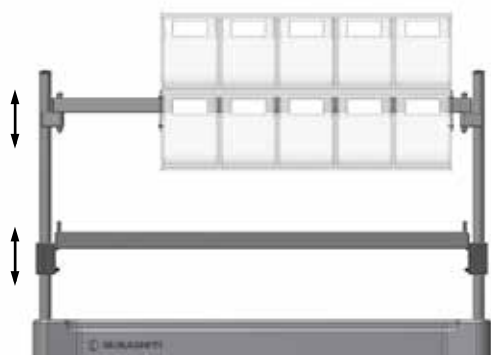

**26(RA5N.A5.R2N) Double Doble**

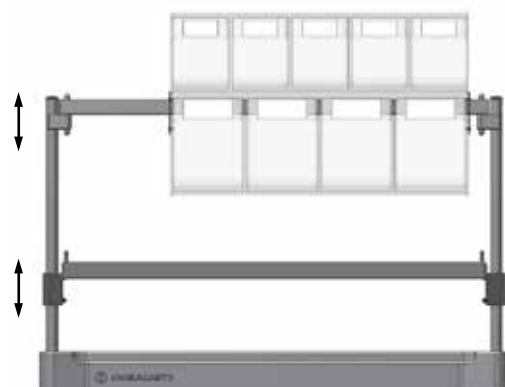

**26(RA4N.A5.R2N) Double Doble**

**ISO FURNITURE ACCESSORIES ACCESORIOS PARA MOBILIARIO ISO**  
**600 x 400 mm ISO DRAWERS CAJONES ISO 600 x 400 mm**

**ISO DRAWER LID TAPA CAJÓN ISO**



**LD** 2 holes for seals  
2 agujeros para precintos

**50 mm ABS ISO DRAWER**  
**CAJÓN ISO 50 mm ABS**

8 Litres Litros



**71**  
**71LD** 2 holes for seals  
2 agujeros para precintos

**100 mm ABS ISO DRAWER**  
**CAJÓN ISO 100 mm ABS**

19 Litres Litros



**72**

**100 mm ABS ISO CLOSED DRAWER**  
**CAJÓN ISO CERRADO 100 mm ABS**

19 Litres Litros



**72C**

**200 mm ABS ISO DRAWER**  
**CAJÓN ISO 200 mm ABS**

33 Litres Litros



**73**

**200 mm ABS ISO CLOSED DRAWER**  
**CAJÓN ISO CERRADO 200 mm ABS**

33 Litres Litros



**73C**

**ISO FURNITURE ACCESSORIES ACCESORIOS PARA MOBILIARIO ISO**  
**600 x 400 mm ISO DRAWERS CAJONES ISO 600 x 400 mm**

**CARD HOLDER FOR OPEN DRAWER**  
**PORTATARJETAS PARA CAJÓN**  
**ABIERTO**



**HCOP**

**NARCOTICS SECURITY BOX**  
**CAJA SEGURIDAD NARCÓTICOS**

Height Altura 80 mm  
 Dimensions Dimensiones 150 x 120 mm  
 Key locking Bloqueo de llave



**CSM** Separated Suelta  
**CSM1** Drawer fixed Fijación cajón

**50 mm POLYCARBONATE ISO DRAWER**  
**CAJÓN ISO 50 mm POLICARBONATO**  
 8 Litres Litros



**71PC**

**100 mm POLYCARBONATE ISO DRAWER**  
**CAJÓN ISO 100 mm POLICARBONATO**  
 19 Litres Litros



**72PC**

**200 mm POLYCARBONATE ISO DRAWER**  
**CAJÓN ISO 200 mm POLICARBONATO**  
 33 Litres Litros



**73PC**

**240 mm HIGH ABS ISO DRAWER**  
**CAJÓN ABS ISO ALTURA 240 mm**



**73BT** Loose drawer unit Cajón suelto  
**AX73.73BT** Mounted on trolley  
 Montado en carro



**ISO FURNITURE ACCESSORIES ACCESORIOS PARA MOBILIARIO ISO**

**RAIL FOR CATHETERS  
RIEL PARA CATÉTERES**

Stainless steel Acero inoxidable  
Adjustable height Altura regulable



**R7CAT3** 3 hooks 3 ganchos Mod. 706  
**R7CAT4** 4 hooks 4 ganchos Mod. 720

**ADJUSTABLE SHELF FOR CATHETERS  
BANDEJA REGULABLE PARA CATÉTERES**



**60CAT** 25 hooks 25 colgadores Mod. 706  
**62CAT** 15 hooks 15 colgadores Mod. 720

**ADJUSTABLE SHELF  
BANDEJA REGULABLE**

Phenolic Fenólico Max. 22 kg



**60** 600 x 440 mm - Mod. 706 / 606  
**62** 400 x 600 mm - Mod. 720 / 620

**ADJUSTABLE SHELF DIVIDER  
SEPARADOR BANDEJA REGULABLE**

Epoxi painted steel Acero pintado epoxi



**DV**

**ENDOSCOPES ADJUSTABLE SHELF  
BANDEJA REGULABLE ENDOSCOPIOS**

Phenolic Fenólico  
10 endoscopes 10 endoscopios

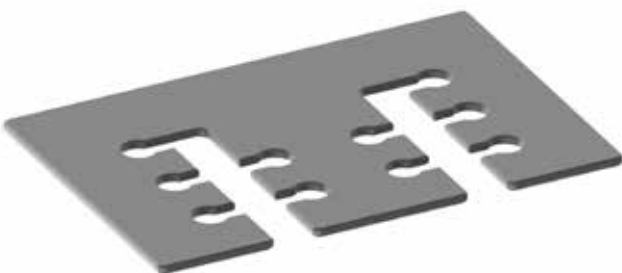

**60ED**

**RETENTION STOP  
TOPE DE RETENCIÓN**

1 set per drawer 1 juego por cajón



**TR**

Faithful to our slogan "Design, Build, Innovate" Insausti has constructed a new forefront factory with the latest technology.

Inaugurated in October 2023 over a land plot of 7.700 m<sup>2</sup>, the building with 4.600 m<sup>2</sup> houses a logistic plant, components assembly area and several production lines.

Fieles a nuestro eslogan "Diseñar, Construir, Innovar" Insausti ha construido una nueva fábrica de vanguardia, con la última tecnología.

Inaugurada en octubre de 2023 sobre unas instalaciones de 7.700 m<sup>2</sup> el edificio de 4.600 m<sup>2</sup> cuenta con planta de logística, área de montaje de componentes y varias líneas de producción.





All articles with EC mark are considered as medical device class I and follow regulation (EU) 2017/745 Sanitary licence 7439-PS. SRN: ES-MF-000003261.

Todos los artículos con la marca CE se consideran producto sanitario de clase I y siguen el reglamento (UE) 2017/745 Licencia Sanitaria 7439-PS. SRN: ES-MF-000003261.

Guarantee period: 5 years

Periodo de garantía: 5 años

INSAUSTI reserves the right to make modifications

INSAUSTI se reserva el derecho a modificaciones



User manual Manual de usuario



Sustainability is a key part of our business.

The new photovoltaic installation generates the clean green energy needed to manufacture Insausti branded medical trolleys, a milestone in our commitment to sustainable activity.

La sostenibilidad es una parte fundamental en nuestra empresa.

La nueva instalación fotovoltaica produce la energía limpia necesaria para la fabricación de los carros médicos marca Insausti, un hito en nuestro compromiso con una actividad sostenible.



**30** YEAR SERVICE LIFE  
AÑOS DE VIDA ÚTIL



Since Desde  
**1991**



Designed and manufactured in Spain

Diseñado y fabricado en España



**INSAUSTI MATERIAL CLÍNICO S.L.U.**

Pol. Ind. Comarca 2 C/A nave 3  
31191 Barbatáin (España - Spain)  
Tel.: (+34) 948 149 588  
e-mail: [insausti@insausti.eu](mailto:insausti@insausti.eu)  
[www.insausti.eu](http://www.insausti.eu)



**2025**