



**Mobile functional furniture  
for the healthcare sector**



**Catalogue valid from 2020**

novocal – care in motion.

As a manufacturer of functional mobile furniture for Health Care, it is our desire to optimize and simplify the working life of nursing staff in hospitals, nursing care and retirement homes. Naturally, your patients are at the centre of your business, and our products allow staff to move from location to location quickly, smoothly and efficiently maximizing your care potential and reducing stress.

We are a technically broad and experienced team based in Ostrhauderfehn in the North of Germany. As a customer you will receive all your bespoke service needs from a single source: advice and quoting, processing and production as well as delivery and instruction.

All our products are made according to individual requirements with service, quality and fine detail our top priority.

Our product range includes functional furniture in the field of laundry logistics and waste management as well as general and special care trolleys, e.g. MRSA, endoscopy or module trolleys. In addition, we also offer all kinds of transport equipment, storage systems and components for sterile surgical areas. Numerous accessories are available to customize your products to suit your individual needs.

Within this catalogue you will find examples of both our wide ranging and individual assortment of products. If you have any special requests or enquiries, please do not hesitate to contact us. We will happily find a solution to any of your requirements. Our customers trust in us to deliver our promises.

Together we can set care in motion.



*Our promise:  
Everything from a single source.  
Reliable, sustainable, individual.  
Your Novocal team*

Overview of available colours

					
White (WS)	Vanilla (VL)	Pastel Yellow (PG)	Lemon Yellow (ZG)	Orange (OR)	Orchid (OC)
					
Red (RT)	Lime Green (LI)	Aqua (AQ)	Light Blue (HB)	Steel-blue (SB)	Silver (SI)
					
Light Grey (LG)	Aubergine (AU)	Anthracite (AZ)	Cashmere (CS)	Basalt (BS)	Lava Grey (LV)
					
Truffle (TF)	Cement (BT)	Acer (AH)	Corsica-Pear (KB)	Acacia (AK)	Norway Maple (SA)
					
Walnut (NB)	Beech (BU)	Oak-Basalt (EB)			

*Please note:  
The pictured colour palette may  
slightly deviate from colour and structure  
of the original material!*

## Laundry Logistics

	Article Number	Catalogue Page
<b>Linen Collectors Stainless Steel</b>		
Wall mounting collector	NW10	11
„Compact“ 1-fold / „Compact plus“ 1-fold with push bar	NW71/NW81	11
„Compact“ 2-fold / „Compact plus“ 2-fold with push bar	NW72/NW82	12
„Compact“ 3-fold	NW73	12
„Compact plus“ 3-fold with push bar	NW83	13
„Compact“ 4-fold / „Compact plus“ 4-fold with push bar	NW74/NW84	13
„Compact“ 5-fold / „Compact plus“ 5-fold with push bar	NW75/NW85	13
„Compact“ 5-fold with centralised lid operating system	NW25-G	13
„Compact plus“ 3-fold to 5-fold with push bar	NW43F/NW44/NW45	14
Combination collector 2-fold / 3-fold with push bar	NW42-KS70/NW43-KS70	14
Combination collector 1-fold to 3-fold with push bar	NW81-KS70/NW82-KS70/NW83-KS70	15
Combination collector 4-fold with push bar	NW84-KS70	15
<b>Accessories Linen Collectors</b>		
Plastic lid with hook holder	KDH	16
Plastic lid w. plastic hinge & soft close system (coloured/transp.)	KDS/KDS-TR	16
Pedal device for hinged lid	TVD	16
Adhesive ring	SR400	16
Synthetic base tub for collectors 1-fold to 4-fold	KBW	16
<b>Linen Bags</b>		
Linen bags, different versions	TW1/TW2	17
Linen bags, waterproof and water-soluble	WTW2/HWW	17
<b>Linen Nets</b>		
Linen nets, different versions	N/NF	18
Toggle/Toggle made of rubber	DIBE/GK	18
<b>Stainless Steel Undercarriages</b>		
Stainless steel undercarriage with plastic tub/with push bar	WW1/WW2	19
<b>Laundry Trolleys</b>		
Overview Laundry trolleys	SW500-SW2000	20-21
Possible arrangements of adhesive rings		22
Laundry trolleys of the series SW500	SW500	23
Laundry trolleys of the series SW600	SW600	24
Laundry trolleys of the series SW700	SW700	25
Laundry trolleys of the series SW800	SW800	26
Laundry trolleys of the series SW900	SW900	27
Laundry trolleys of the series SW1000	SW1000	28
Laundry trolleys of the series SW2000	SW2000	29

## Patient Care and Nursing Trolleys

<b>PAW</b>		
Overview Patient Care and Nursing Trolleys	PAW3000-PAW7000	30-31
Individual production		32
Patient care and nursing trolleys of the series PAW3000	PAW3000	33
Patient care and nursing trolleys of the series PAW4000	PAW4000	34
Patient care and nursing trolleys of the series PAW5000	PAW5000	35
Patient care and nursing trolleys of the series PAW6000	PAW6000	36
Patient care and nursing trolleys of the series PAW7000	PAW7000	37
Patient care and nursing trolleys of the series PAW8000	PAW8000	38
Patient care and nursing trolleys of the series PAW9000	PAW9000	39

# Contents



	<b>Article Number</b>	<b>Catalogue Page</b>
<b>Medicine Trolleys</b>		
Medicine trolleys, various versions	MEDI5001/MEDI6002	40
Accessories		41
<b>Module Trolleys</b>		
Module trolleys series 6000	MOD	42
Module trolleys, open versions	OMW	43
Roll-Up utility trolley	RUWI	43
<b>Modules</b>		
ISO modules ABS, divisible, different sizes	ABS	44
ISO modules PC, divisible, different sizes	PC	45
Wire-netted baskets, different sizes	GK	45
<b>Baby Changing Trolleys</b>		
Baby changing trolleys, various versions	WW	46
<b>System Trolleys</b>		
System trolley "Modula"	NSW/NSWK	47
<b>Endoscopy Trolley</b>		
Endoscopy trolley	ENDO61000	48
<b>Document Trolleys</b>		
File and ward round trolley	NKV	49
Ergonomic documentation trolley, various versions	EDW	50
<b>Catheter Trolleys</b>		
Catheter trolley, various versions	KW1/KW2	51
<b>Functional Trolleys with synthetic Surfaces</b>		
Phoenixcare Cetos, various versions	CETOS	52-53
Patient trolley	PATW	54
<b>Computer and IT Trolleys</b>		
<b>Computer Trolleys</b>		
Computer trolley I, various versions	CW4000	55
Computer trolley II, various versions	CW5000	56
Computer trolley III, various versions	CW6000	57
IT trolley I	EDVW5400	58
IT trolley II	EDVW6102	59
<b>Laptop Trolleys</b>		
Laptop trolley (lowerable laptop compartment), various versions	LAW4000A	60
Laptop trolley (sideward-extendable laptop compartment), various versions	LAW4000S	60
Laptop trolley, height adjustable	LAW4300H	61
<b>iPad Trolley</b>		
iPad trolley	IPW4400	62
<b>Power Supply Systems</b>		
Power Supply System	PSS	63

## MRSA / ISO Trolleys

	Article Number	Catalogue Page
<b>Disinfection Stations</b>		
DESI, mobile/floor model	DESI1/DESI2	64
Desicenter, stainless steel	DESICENTER-VA	65
Desicenter, coloured	DESICENTER-F	65
UV-C disinfection unit	UEKG01	66-67
<b>MRSA trolley</b>		
MRSA trolley with closed back and racks	MRSA1F	68
MRSA trolley with closed back and girder support system	MRSA1M	68
MRSA trolley with stainless steel back and racks	MRSA2F	69
MRSA trolley with stainless steel back and girder support system	MRSA2M	69

## Accessories

Sideways fold-away working surface	SPA1	71
Extendable writing surface	SPA2	71
Sideways height-adjustable working surface (installation on the left/right)	SPA1H-L/SPA1H-R	71
Stainless steel plating, different sizes	EAK	71
ABS synthetic top, different sizes	ABSTOP	71
Tubular frame, different sizes	RGE	71
Side compartments	SF50	72
Girder support systems for ISO modules	MTW	72
Dividers for drawers - lengthwise/transverse	LTS/QTS	72
Surgical instrument container, incl. stainless steel fitting	IAB	72
Swab dispenser, euro-rack model	TSE	72
Medibox (septobox / hallow needle box), 1,5 l	MB	72
Medibox mounting, various versions	MBH	72
Medibox mounting (set)	MBHS	72
Sliding handle, for installation on the left/right	BSL/BSR	72
Disinfectant dispenser, different sizes and versions	DMS	73
Disinfectant dispenser, 500 ml, automatic	DMSA	73
Drip pan, different sizes and versions	TS	73
Disinfectant closure plate, lockable	DMSV	73
Stainless steel pump with dosing limitation for disinfectant dispenser	EPD	73
Euro-rack, stainless steel, single-row/double-row	ES1/ES2	74
Euro-rack, stainless steel, height adjustable, single-row/double-row	ES1H/ES2H	74
Euro-rack, stainless steel, for lateral mounting	ESS	74
T-mounting	TH	74
F-mounting, for installation on the left/right	FHL/FHR	74
Stainless steel container for Euro-rack	EBHES	74
Implement basket	UTBES	74
Glove box mounting, various versions	HSB	75
Bins, various versions and sizes	SCHUETTEN	76
Wire-netted baskets	GK	76
Coat hooks, stainless steel	PHE	76
Coat hooks, plastic	PHK	76
Stainless steel kidney dish	NRS01	76
Catheter tubes, different sizes and versions	KK	76
Mounting for mouth protection box	MUBH	76
Automatic sensor waste bin, 8 l	KB8A	77
Automatic sensor waste bin, 8 l, incl. stainless steel fitting	KB8A-E	77
Synthetic waste bin, 9 l for PAW and SW	KB9	77
Synthetic waste bin, 9 l, incl. stainless steel fitting	KB9-E	77
Synthetic waste bin, 15 l for PAW and SW	KB15	77
Synthetic waste bin, 15 l, incl. stainless steel fitting	KB15-E	77
Hygienic waste bin SLIDE, various sizes and versions	SLIDE	77

	<b>Article Number</b>	<b>Catalogue Page</b>
Cylindrical twist lock	ZY	78
Combination lock in two versions	ZS	78
Electronical numeric code pad	BSML	78
Transponder lock	TPS01	78
Monitor mounting	MH	78
iPad mounting	IPH	78
Furniture safe, various versions	MT1/MT2	78
Drip stand holder / IV-pole holder	IFH	79
Oxygen-cylinder holder	SFH01	79
Master adjusting device for patient care and nursing trolleys	ZFS	79
Magnetic holder	HMF	79
Door holder, central	DFST	79
Wheels, various versions		80
Shelf for defibrillator	ADEF	80
Reanimation panel	RP01	80
help-System/fire extinguisher system		80

## Waste Collectors

### Waste Collector, Stainless Steel

Waste collector „Compact“ 1-4-fold, stainless steel	NA	81
---	----	----

### Waste Collector „Genius“

Waste collector „Genius“, floor model, 40 l/70 l	S40/S70	82
Waste collector „Genius“, mobile, 40 l/70 l	S40L/S70L	82
Waste collector „Genius“, mobile, 70 l, 2-fold	S70L-2	82
Waste collector „Genius“ with braking function	S70L-B	83
Accessories for waste collector „Genius“		83

### Waste Collector with Bag Cassette/with Vacuum Unit

Bag cassette, various versions	LGP	84
Collector for bag cassette	NAL	84
Waste sealing unit with closed undercarriage, various versions		85
Waste sealing unit with open undercarriage, various versions		85
Waste collector „Genius Plus“	S70LPLUS	86
Valve bags	VSTP01	86
Vacuum device NOVOVAC	NOVOVAC01	87
Vacuum bags, white/transparent	VAKWS01/VAKTP01	87

### Recyclable collector

Recyclable collector for synthetic containers, 50 l, 1-4-fold	GSE	88
Recyclable collectors of the series 2000, various versions	NWE	89
Room recyclable collector, 2-4-fold	ZSE	90
Recyclable collector with coloured synthetic boxes, various versions	WKK	91
Recyclable cabinet of the series 3000, 1-4-fold	ZWK	92
Recyclable cabinet, stainless steel, 1-4-fold	EWK	93
Recyclable cabinet, aluminium, 1-4-fold	NWKA	94

### Waste collector with pedal

Pedal dust bin, stainless steel	EE	95
Pedal dust bin, galvanized, various sizes	EL	95
Pedal dust bin, stainless chromium steel, various sizes	EC	95
Closable dustbin, stainless steel, various sizes	GAE	95

## Transport and Storage systems

	Article Number	Catalogue Page
<b>Drug Cabinets</b>		
Drug cabinets	MS	96-97
<b>Storage System</b>		
Series FLEXISTORE	FLEXISTORE	98-99
<b>Multi-purpose Trolleys</b>		
Multi-purpose trolley, stainless steel, solid core shelves	SEV	100
Multi-purpose trolley, stainless steel, melamine resin coated shelves	SEM	100
Multi-purpose trolley „Silverline“	S	101
Multi-purpose trolley, synthetic	4091/4093	101
Multi-purpose trolley, stainless steel, closed	SEG	102
Multi-purpose trolley, stainless steel, open	SE	102
<b>Serving Trolleys</b>		
Tea cart	FS	103
<b>Tray Trolley</b>		
Tray trolley, various versions	TW	103
Tray trolley, stainless steel, various versions and sizes	TBW	104
<b>Sorting Trolleys</b>		
Combined sorting trolleys, various versions and sizes	KSR	105
Coat stand, various versions and sizes	KI	105
Rack trolleys, various versions and sizes	RA	106
<b>Sorting Rack Trolley</b>		
Sorting rack trolley, various versions and sizes	SR	107
Standing racks, various versions and sizes	ST	108
Compartment dividers	F	109
Corner posts	P	109
Grid shelves	GB	109
Border grids	RG	109
Textile protective cover	H	110
Pull-out clothing rail	AK	110
Label holder	EK	110
Border poles	RSB	110
Sliding handle for rack trolleys	BSR	111
S-shaped hooks	SH	111
Brackets for border poles	KKL	111
Buffer plates	SSR	111
Directional locking	RIFIX	111
Base plate	FP	111
<b>Transport Trolleys</b>		
Skeleton container trolley	GTR	112
Transport trolley, stainless steel, foldable shelves	TRE91	112
Transport trolley, stainless steel, with / without back, various sizes	TRE	113
Front wall trolley	STE	113
<b>Cabinet Trolley</b>		
Module trolley, closed, various versions	GM	114
Cabinet trolley, aluminium, various versions and sizes	GS	115-117
Spring-base trolley, various sizes	GFW	118



	<b>Article Number</b>	<b>Catalogue Page</b>
Transport containers, aluminium, water-tight	GTC1	118
Transport container, aluminium, with side panel cut-outs, various sizes	GTC2	118
Transport container, aluminium, hinged lid	GTC350	119
Transport container, aluminium, open	GTW	119
Transport container, aluminium, with foldable front panel	GTWK	119
Transport boxes, aluminium, various sizes	TK	120
Transport container, aluminium, perforated	GTW/L	121

## OP Equipment

### Transport Trolleys for Sterile Materials

Transport trolleys for sterile materials for inner module frames	CI-STGW	122
Inner frame for transport trolleys	CI-IRA	123
Transport trolleys for sterile materials with bearing rails for modules	CI-STGW	124-125
Transport trolleys for sterile materials with fixed/movable shelves	CI-STGW-FB/-A	126
Rack trolley for sterile materials	CI-STGR	127
Sterile cabinet	CI-STG-SCHRANK	127

### OP Equipment

Drip stand/IV-pole	IS	128-129
Accessories for drip stand/IV-pole		130-131
OP stool, various versions	CI-OPH	132
OP tables, various versions	CI-OPB	133
Table for OP instruments, various versions	IE01/CI-IES	134
Working and storage table, mobile and floor model	ATE/CI-ATE	135

## Stainless Steel Fabrications

Operation room step	OPT	136
Bowl retainer	SST01	136
Trolley for abdominal bandages	BTW01	136
Hook trolley	HW01	136
Room cleaning trolley	RW01	137
Lab coat stand, stainless steel, various sizes	KI	137
Mangle rack, stainless steel, various sizes	MB	137
Stainless steel mounting for urine bottles, various versions	UF	138
Stainless steel mounting for toilet pails, various versions	TE	138
Stainless steel mounting for bedpans, various versions	SB	138
Stainless steel wall shelf	WSU	138
Trolley for bedpans and urine bottles	TW-US8	138
Shoe rack, various versions	WSR/SRW	139

## Seating

ModernArt	140
Relax'nFit	141-142

## Index

Index of abbreviations and article numbers in alphabetic sequence	144-145
---	---------

**PAW3000**  
see page 33

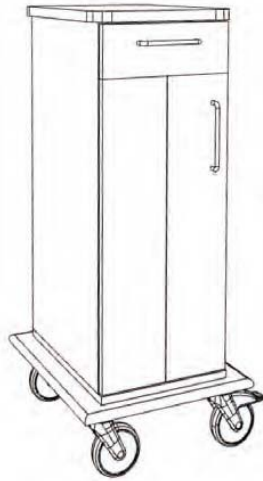

**Patient Care and Nursing Trolleys PAW**

Our patient care and nursing trolleys series PAW3000 to PAW9000 allow the flexible use in all areas of patient care and nursing. From a multitude of combination possibilities you will find examples of each series' models on the following pages. Like our laundry trolleys, our patient care and nursing trolleys are available in various colours.

Cabinet and fascia colour can be chosen individually.

**Undercarriage**

The undercarriage is made up of a solid plastic sheet, which also serves as wall-stopper. Four castor wheels (from PAW6000 up with five castor wheels) Ø 125 mm, with two brakes, guarantee easy use.

**Cabinet**

The cabinet consists of special high quality sheets and worktops of quality class E1 with a double-sided melamine resin coating and a two mm thick ABS-safety edge foil.

**Working Surface**

As standard, all patient care and nursing trolleys have a working surface with rounded edges. The soft-drawers run on telescopic slides, which have a self-closing function.

The storage shelves are adjustable in height and can be taken out completely.

Standard colour: light grey (LG)

Edge veneer: light grey (LG)

Special colours on request.

**Accessories**

- stainless steel gallery
- ABS top
- divider for drawers
- functional tracks/rails
- mounting for bins
- fold-away working surface
- girder support system for modules

The complete overview of accessories available for our patient care and nursing trolleys can be found on pages 71-80.

It would be our pleasure to be your consultant and offer you a customised proposal based on your specific needs.

**PAW4000**  
see page 34

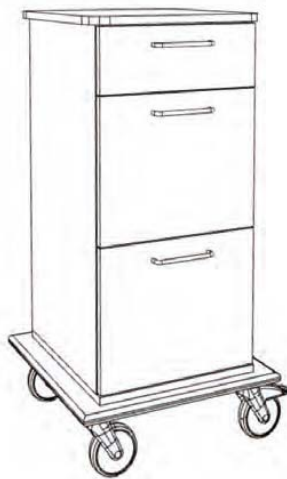

**PAW5000**  
see page 35

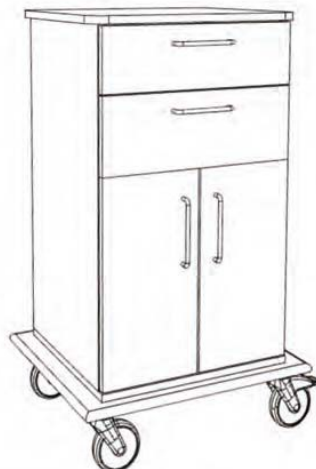

## Overview Patient Care and Nursing Trolleys

**PAW6000**  
see page 36



**PAW7000**  
see page 37



**PAW8000**  
see page 38



**PAW9000**  
see page 39



Article Number	Cabinet Dimensions BxDxH mm
PAW3000	356 x 490 x 905
PAW4000	450 x 490 x 905
PAW5000	550 x 490 x 905
PAW6000	656 x 490 x 682
PAW7000	712 x 490 x 905
PAW8000	800 x 490 x 905
PAW9000	900 x 490 x 905

Article Number	Total Dimensions BxDxH mm
PAW3000	476 x 570 x 1085
PAW4000	570 x 570 x 1085
PAW5000	670 x 570 x 1085
PAW6000	776 x 570 x 862
PAW7000	832 x 570 x 1085
PAW8000	920 x 570 x 1085
PAW9000	1020 x 570 x 1085

**Individual Work Environments require individual Solutions:**

That is the reason why we offer our patient care and nursing trolleys in two different depths:

**490 mm and 600 mm.**

**Model Examples:**

PAW 7002

left: BxDxH =  
712 x **490** x 905 mm

right: BxDxH =  
712 x **600** x 905 mm

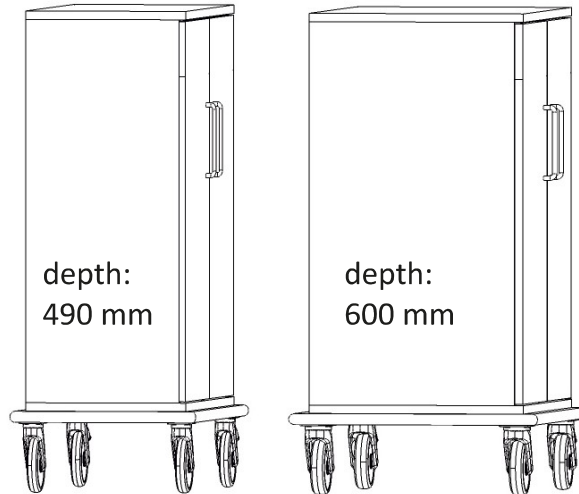

**The following explanation shows how the product name is composed:**

**PAW 8121**

**PAW: Product name**

- 8** : series 8000
- 1** : number of drawers
- 2** : number of document extracts
- 1** : number of doors

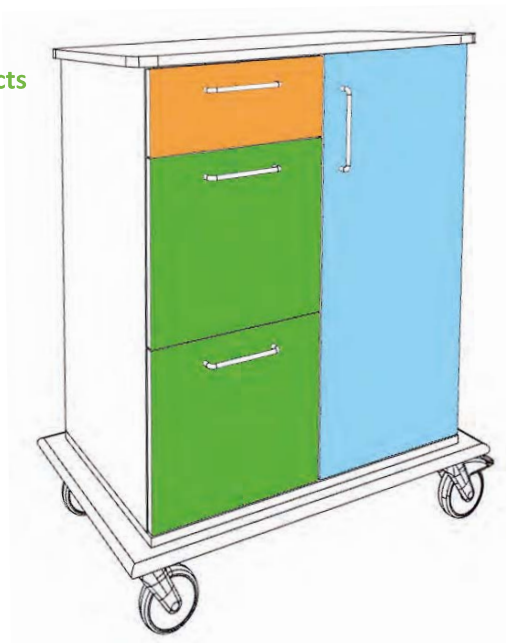

# Patient Care and Nursing Trolleys



**PAW3001**

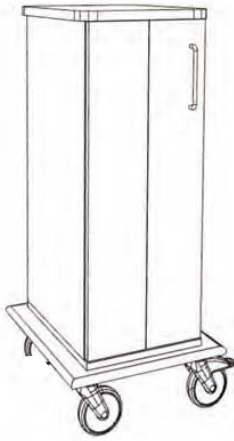

**PAW3101**

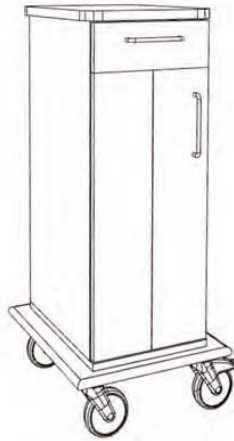

**PAW3201**

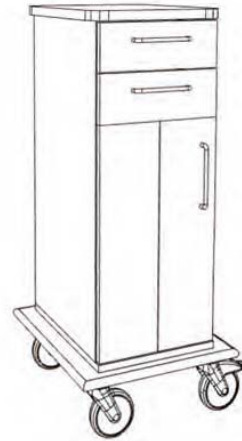

**PAW3001**

Image with optional accessories ABSTOP, ZY and BS4L



**PAW3500**

Image with optional accessories ABSTOP and SPA1H



**PAW3201**

Image with optional accessories ABSTOP and KB15-E



**PAW3001**

Image with optional accessories ABSTOP, SPA1, MTW and diff. modules



## Patient Care and Nursing Trolleys PAW 3000

The interior of this series can be equipped with a girder support system for modules, in order to utilise ISO modules or wire-netted baskets (BxH: 300 x 400 mm) (see p. 44-45). The PAW3000 can be equipped either with drawers or a hinged folding door. The standard colour is light grey (LG).

**All shown models are only an excerpt from our product range.**

Cabinet Dimensions	Total Dimensions BxDxH mm
356 x 490 x 905	476 x 570 x 1085

Seating Stainless Steel Fabrications OP Equipment Storage / Transport Systems Waste Collectors Accessories ISO Trolleys IT Trolleys Patient Care and Nursing Trolleys Laundry Logistics

**PAW4002**

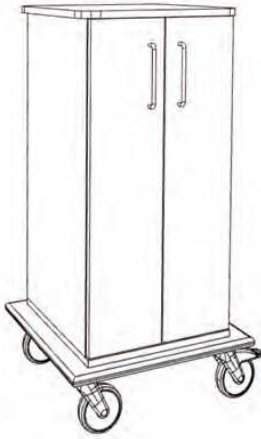

**PAW4120**

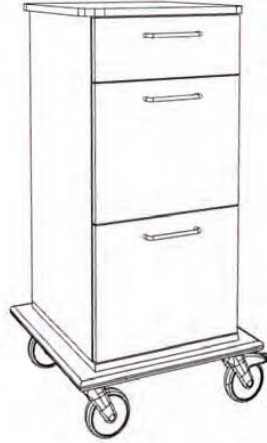

**PAW4112**

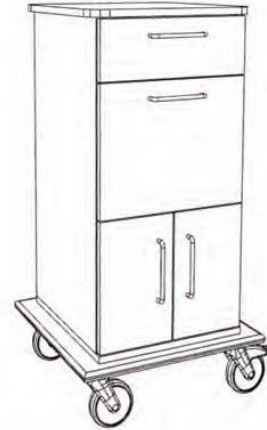

**PAW4120**  
Image with optional accessory ZE



**PAW4001**  
Image with optional accessories SPA1R, BS4L, FHR, DMS5, TS5, KB15E and HMF



**PAW4120**  
Image with optional accessories ZE, ABSTOP and SPA1L



**PAW4500**  
Image with optional accessories ABSTOP, ZE and SLIDE15



**Patient Care and Nursing Trolleys PAW4000**

The PAW is available with either fixed doors or a folding door. Open shelves, drawers, document folders, X-ray boxes and inner drawers are available.

The standard colour is light grey (LG).

**All shown models are only an excerpt from our product range.**

Cabinet Dimensions	Total Dimensions BxDxH mm
450 x 490 x 905	570 x 570 x 1085

# Patient Care and Nursing Trolleys



**PAW5120**

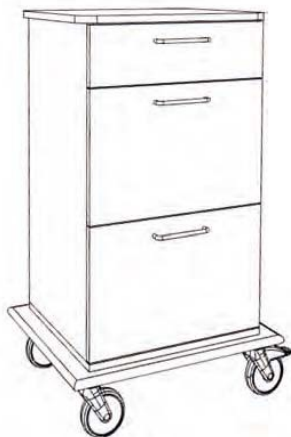

**PAW5202**

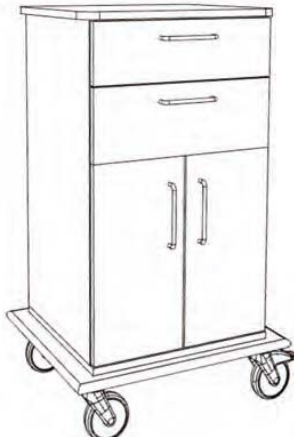

**PAW5110**

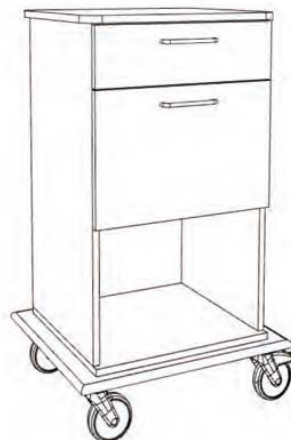

**PAW5300**

Image with optional accessories SPA1R and BS4L



**PAW5102**

Image with optional accessories SPA2, ABSTOP, and DFT



**PAW5202**

Image with optional accessory ABSTOP



**PAW5500**

Image with optional accessories ABSTOP and SPA1L



## Patient Care and Nursing Trolleys PAW5000

The PAW5000 is available with either fixed doors or a folding door. Open shelves, drawers, document folders, X-ray boxes and inner drawers are available.

The standard colour is light grey (LG).

**All shown models are only an excerpt from our product range.**

Cabinet Dimensions	Total Dimensions BxDxH mm
550 x 490 x 905	670 x 570 x 1085

**PAW6102**



**PAW6401**



**PAW6700**



**PAW6102**

Image with optional accessories SPA1R and BS4L



**PAW6210**

Image with optional accessories ABSTOP and 2 ESS



**PAW6500**

Image with optional accessories RGE, BS4L and SPA1R



**PAW6400**

Image with optional accessories ES2, HSB3QPAW, DMS5, ABSTOP and SCHUETTEN4



**Patient Care and Nursing Trolleys PAW 6000**

The interior of this series can be equipped with a girder support system for modules, in order to utilise ISO modules or wire-netted baskets (BxH: 300 x 400 mm). See p. 44-45 for further details. The PAW6000 is available with either fixed doors or a folding door.

The standard colour is light grey (LG).

**All shown models are only an excerpt from our product range.**

Cabinet Dimensions	Total Dimensions BxDxH mm
656 x 490 x 682	776 x 570 x 862



# Patient Care and Nursing Trolleys



**PAW7002**

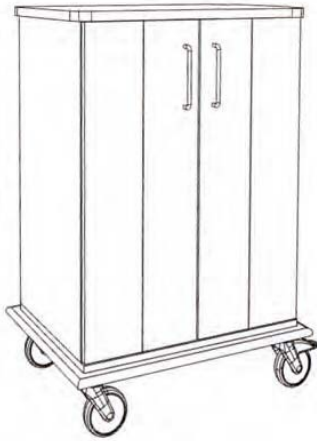

**PAW7102**



**PAW7202**



**PAW7002**

Image with optional accessories ABSTOP, MTW and diff. modules



**PAW7202**

Image with optional accessories ABSTOP, BS4L, MTW and diff. modules



**PAW7102**

Image with optional accessory ABSTOP



## Patient Care and Nursing Trolleys PAW 7000

Optionally, a partition plate can be installed to separate the cabinet in two. Also, a girder support system for modules can be utilised. This means that on both sides ISO Modules as well as wire-netted baskets (BxH: 300 x 400 mm) can be used. See p.44-45 for further details.

The standard colour is light grey (LG).

**All shown models are only an excerpt from our product range.**

Cabinet Dimensions	Total Dimensions BxDxH mm
712 x 490 x 905	832 x 570 x 1085

Seating Stainless Steel Fabrications OP Equipment Storage / Transport Systems Waste Collectors Accessories ISO Trolleys IT Trolleys Patient Care and Nursing Trolleys Laundry Logistics

**PAW8121**



**PAW8501**



**PAW81000**



**PAW8121**

Image with optional accessories ZE, BS4L and ZY



**PAW8310**

Image with optional accessories RGE, FHL, DMS5, TS5, BS4L, HSB2, ZY and SPA1R



**PAW8500**

Image with optional accessories ES2, DMS5, TS5, ABSTOP, KB15-E and 2x SCHUETTE5



**Patient Care and Nursing Trolleys PAW 8000**

The PAW is either available with fixed doors or folding doors. Open shelves, drawers, document folders, X-ray boxes and inner drawers are available.

The standard colour is light grey (LG).

**All shown models are only an excerpt from our product range.**

Cabinet Dimensions	Total Dimensions BxDxH mm
800 x 490 x 905	920 x 570 x 1085

# Patient Care and Nursing Trolleys



**PAW9240**



**PAW9620**



**PAW9311**



**PAW9102**

Image with optional accessories ES1 and ABSTOP



**PAW9212**

Image with optional accessories TH, DMS5, TS5 and BS4L



**PAW9800**

Image with optional accessories ABSTOP, SPA1H and SLIDE15



## Patient Care and Nursing Trolleys PAW9000

The PAW9000 is available with either fixed doors or a folding door. Open shelves, drawers, document folders, X-ray boxes and inner drawers are available.

The standard colour is light grey (LG).

**All shown models are only an excerpt from our product range.**

Cabinet Dimensions	Total Dimensions BxDxH mm
900 x 490 x 905	1020 x 570 x 1085

Seating Stainless Steel Fabrications OP Equipment Storage / Transport Systems Waste Collectors Accessories ISO Trolleys IT Trolleys Patient Care and Nursing Trolleys Laundry Logistics

**MEDI5001**

Image with optional accessories FHR, MB, KB15-E, BS4L, SPA1R, BLB, BSML and diff. modules



**MEDI6002**

Image with optional accessories FHR, MB, KB15-E, BS4L, SPA1R, BLB, ZY and diff. modules



**Medicine Trolleys**

The medicine trolleys enable a flexible transport as well as an organised storage of all drugs.

The undercarriage is made up of a solid plastic sheet, which also serves as wall-stopper. The cabinet consists of special high quality sheets and worktops of quality class E1 with a double-sided melamine resin coating and a two mm thick ABS-safety edge foil.

Moreover, the MEDI5001 features one hinged folding door with door holder central and magnet at the undercarriage. Four castor wheels, Ø 125 mm, two with brakes, allow easy handling. The trolley is equipped with an electronic locking system.

The interior is made up as follows:

- 1 extractable shelf
- 5 fully extendible drawer runners with ISO modules format 450 x 400 x 100 mm incl. 3 dividers 400 x 100 mm and 2 dividers 450 x 100 mm
- 20 indicator plates

The trolley features the following standard exterior:

- 1 push bar
- 1 fold away writing surface on the right side 350 x 480 mm
- 1 waste bin 15 Litre with stainless steel mounting
- 1 F-mounting on the right side of the back

The medicine trolley MEDI6002 is constructed as follows:

- 1 push bar
- 2 doors incl. cylindrical lock
- 4 compartments in the doors
- in the cabinet stainless steel rails for 36 Trays (variable for 4-fold or 6-fold trays)



Article Number	Cabinet Dimensions BxDxH mm
MEDI5001	506 x 460 x 905
MEDI6002	656 x 490 x 905
Total Dimensions BxDxH mm	
MEDI5001	630 x 540 x 1085
MEDI6002	776 x 570 x 1085

# Medicine Trolleys



## Accessories for Medicine Trolleys

### Blister box (BLB)



The **push bar (BSL)** guarantees high usability. For a quick and hygienic waste disposal a **waste collector for 15 liters (KB15-E)** is mounted standardly.



**ABS-Top (ABSTOP)** for the top work- and writing surface incl. three-sided edge



The **electronical numeric code pad (BSML)** avoids unauthorised access to drugs and nursing materials. The MEDI6002 is locked by two **cylindrical locks (ZY)**.



The fold-away working surface (**SPA1**) (350 x 470 mm) can be operated with one hand. It is robust and the usage is easy.



The trolleys are equipped with an **F-mounting (FHL/FHR)** incl. a **stainless steel mounting (MBH)** for mediboxes (**MB**).



**MOD6300K**



**Module Trolley Series MOD6000**

Our modern module trolleys are ergonomically designed and built in a user-friendly manner. They are equipped with fully extendible drawer runners for easy insertion and removal of ISO modules or wire-netted baskets. This series can be equipped with modules or baskets with heights of 50 mm, 100 mm or 200 mm (baskets 180 mm). Modules and baskets can be found from page 44 onwards. You can choose from pull-out blinds, 270 degrees swing-out doors or fully retractable hinged doors.

The cabinet is made of high quality special sheets, quality class E1 with double-sided melamine resin coating and a two mm thick ABS-safety edge foil. It is available in two heights with various colour schemes, according to our colour chart on page 10.

The working surface has rounded edges. The undercarriage is made up of a solid plastic sheet, which also serves as wall-stopper. Silent and easy movement is guaranteed by four castor wheels Ø 125mm, with two brakes. A stainless steel push bar is included. All drawers are equipped with recessed handles.

**MOD6102GM**

Image with optional accessories ABSTOP, BS4L, tray extension, ZY and diff. modules



**MOD6000GR**

Image with optional accessories ABSTOP, KB15-E und BS4L (incl. roller blind operable from left to right)



**MOD6002GA5M**

Image with optional accessories ABSTOP, BS4L, ZY and diff. modules



Article Number	Cabinet Dimensions BxDxH mm
MOD6300K	656 x 490 x 680
MOD6000GR/MOD6102GM/MOD6002GA5M	656 x 490 x 905
	Total Dimensions BxDxH mm
MOD6300K	776 x 570 x 860
MOD6000GR/MOD6102GM/MOD6002GA5M	776 x 570 x 1085

## Module Trolleys

### Open Module Trolleys

Our module trolleys can be delivered either in open fashion with stainless steel frame and guide rails or closed with ABS girder support system.

The module trolleys can be produced in different sizes. All ABS modules are heat resistant up to 85 degrees Celsius; the PC modules are heat resistant up to 121 degrees Celsius. Dividers are available for the individual modules.

Custom-made products are available on request.

#### OMW110



Article Number		Cabinet Dimensions BxDxH mm
OMW15	1 row per 5 Modules	570 x 780 x 1110
OMW110	1 row per 10 Modules	570 x 660 x 1620
OMW220	2 row per 10 Modules	1000 x 660 x 1620

### Roll-Up Utility Trolley

The roll-up utility trolley is designed specifically for your everyday care. The optional ABS plastic top is a disinfectant resistant work surface. The front of the RUWI can completely be closed by a lockable roller blind.

This cart is equipped with a girder support system for modules, in order to utilise ISO modules or wire-netted baskets (BxH: 600 x 400 mm). See page 44-45 for further details on accessories.

The cabinet colour is available as per our colour chart on page 10, the lockable blind is always delivered in silver.

The undercarriage is made of a solid plastic sheet. It also functions as wall stopper. Four castor wheels Ø 125 mm, with two brakes, guarantee easy use. The cabinet is made of special sheets, quality class E1 with double-sided melamine resin coating and a two mm thick ABS-safety edge foil.

#### RUWI



RUWI	
Total Dimensions	Cabinet Dimensions BxDxH mm
656 x 500 x 1055	776 x 580 x 1235

**Entire and half modules**

**width: 600 mm**

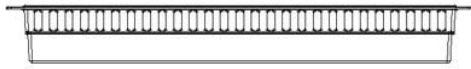

**depth: 400 mm**



**width: 400 mm**

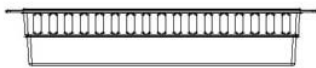

**depth: 300 mm**



**ABS4310**



**ABS4320**



**ABS6405**



**ABS6410**



**ABS6420**



**ABSK6410**



**ABSK6420**



## Modules and Wire-Netted Baskets

### ISO Modules and Wire-Netted Baskets

Our ISO modules and wire-netted baskets are made to transport and store a big variety of materials in our ward-round or module trolleys. All modules are available in different heights for use with our module girder support system or our module trolleys as well as an entire or half module (see image on the left).

All ISO modules come in grey colour (ABS - Acrylonitrile-Butadiene-Styrene copolymers) and transparent (PC - polycarbonate). The wire-netted baskets are white and rilsan coated. All modules are divisible and equipped with an integrated stopping device. Dividers for ABS, PC and GK are available in all relevant sizes.

The ABS and PC modules are tiltable (32°). This makes it easier to view and access contents. The wire-netted baskets do not have this option.

Article Number	Total Dimensions BxDxH mm
ABS4305 (not shown)	400 x 300 x 50
ABS4310	400 x 300 x 100
ABS4320	400 x 300 x 200
ABS6405	600 x 400 x 50
ABS6410	600 x 400 x 100
ABS6420	600 x 400 x 200
ABSK6410	600 x 400 x 100
ABSK6420	600 x 400 x 200
PC4305	400 x 300 x 50
PC4310	400 x 300 x 100
PC4320	400 x 300 x 200
PC6405	600 x 400 x 50
PC6410	600 x 400 x 100
PC6420	600 x 300 x 200
PCK6410	600 x 400 x 100
PCK6420	600 x 400x 200
GK3410	400 x 300 x 100
GK3418	400 x 300 x 180
GK6410	600 x 400 x 100



## Modules and Wire-Netted Baskets

**PC4305**



**PC4310**



**PC4320**



**PC6405**

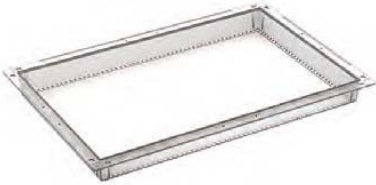

**PC6410**

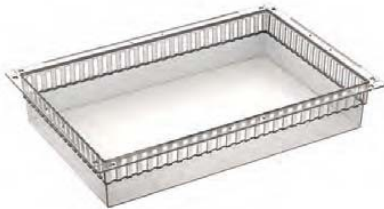

**PC6420**



**PCK6410**



**PCK6420**



**GK3410**



**GK3418**



**GK6410**



**GK6418**



**ASM**

Stopping device for  
ABS- und PC-modules



**ASD/ASK**

Stopping device for  
wire-netted and  
plastic baskets



## Baby Changing Trolleys

The WW6102 with its large drawer offers enough space for all the utensils needed in the care of babies. The lower part has a cabinet with two integrated shelves. This expands the storage space for diapers etc.

The WW6202 has two small drawers on the left side as well as an extendable garbage container concealed by a door. On the right side there is a fixture tool with adhesive ring SR400 behind a door for textile linen bags.

The undercarriage is made up of a solid plastic sheet, which also serves as wall-bumper. Four castor wheels Ø 125mm, with two brakes, guarantee easy use.

The cabinet consists of special high quality sheets and worktops of quality class E1 with a double-sided melamine resin coating and a 2 mm thick ABS-safety edge foil.

### Changing Pads

- 5 cm thick changing pad with 3-sided upstands
- free of PVC, latex und silicon
- resistant to MRSA und Norovirus
- impervious to fluids such as blood, urine, water or coffee
- permanently wipe-clean sterile
- permanently boil-proof to 95°C
- suitable for tumble drying to 120°C
- suitable for vacuum-steam-vacuum procedure to 105°C



#### Available colors



### HZS

Radiant heater for baby changing trolley



**Cabinet Dimensions**

705 x 620 x 682

**Total Dimensions BxDxH mm**

780 x 680 x 1012

## Baby Changing Trolleys

### WW6102

with changing pad



### WW6202

with changing pad, SR400 and BS4L-T



### HZS-H

Stainless steel mounting for radiant heaters



# System Trolleys Modula



**NSWK**  
with 1 SMK  
and 1 FMK



**NSWK**  
with 1 SMK  
and 2 FMK



**NSW**  
with 2 SM  
and 1 FM



## System Trolley Modula

Our system trolley Modula can be used wherever documents, records and utensils have to be stored in an organised yet readily available manner. The robust undercarriage is wholly made of stainless steel. Up to four modules (drawers and compartments) can be accommodated. Four synthetic castor wheels Ø 75mm, with two brakes, ensure easy handling. The system trolley Modula is available in two different widths (540 mm and 690 mm).

Images shown in this catalogue are just an extract of the whole series available.

It would be our pleasure to offer you an individually customised proposal.

**NSWK**  
with 3 SMK  
and RGE (optional)



Article Number	Total Dimensions BxDxH mm
<b>NSW</b> rack	690 x 400 x 820
<b>NSWK</b> rack	540 x 400 x 820
<b>SM</b> drawer	600 x 400 x 160
<b>SMK</b> drawer	450 x 400 x 160
<b>FM</b> compartment	600 x 400 x 19
<b>FMK</b> compartment	450 x 400 x 19
<b>RGE-NSW</b> Tubular frame for NSW	
<b>RGE-NSWK</b> Tubular frame for NSWK	

**Endoscopic Trolley**

The undercarriage is made up of a solid plastic sheet, which also serves as wall-stopper. The cabinet consists of special high quality sheets and worktops of quality class E1 with a double-sided melamine resin coating and a two mm thick ABS-safety edge foil. The worktop has rounded corners.

Four castor wheels, Ø 125 mm, two with brakes, guarantee easy handling.

**Equipment and Accessories:**

- double-row euro-rack, height adjustable
- extended euro-rack on the left side for disinfectant dispenser (500 ml) with drip pan
- infusion-bottle holder on the right side, height adjustable
- Medibox set, 10 boxes, content 1.5 l incl. 1 stainless steel mounting
- box for PE-forceps
- 1 drawer, 96 mm (1.5 RU)
- 1 drawer, 128 mm (2.0 RU)
- 4 drawers on the left and 4 drawers on the right side, each 160 mm (2.5 RU)

See page 71 for more accessories.

**ENDO61000**

Image with optional accessories DMS5, TS5, ES2H, HSB1, EBHES, BS6R, ENDOHR and KB15-E



**ENDO61000**

Image with optional accessories DMS5, TS5, ES2H, HSB1, ENDOHR, BS6R, EBHES and KB15-E



Cabinet Dimensions	Total Dimensions BxDxH mm
656 x 600 x 905	776 x 680 x 1085

# File and Ward Round Trolleys



**NKVR10**  
with lockable roller blind



**NKV20-1**  
with lockable sliding trays  
and one drawer



**NKV30-1**  
with lockable  
sliding trays  
and one  
drawer



## File and Ward Round Trolley

The file and ward round trolley is specifically designed for ward rounds and the administration of personal records in nursing homes. Furthermore, this trolley is an absolute necessity for administration offices in wards or living areas in aged persons homes.

All records are clearly arranged and stored in a readily available manner. Both upper sliding trays can be used as writing surfaces and are equipped with a cylindrical lock.

Optionally also a roller blind is available for purchase. The fully synthetic undercarriage protects walls from damage. The trolleys have four castor wheels, Ø 125mm, with two brakes.

Upon request the file and ward round trolleys bottom part can be equipped up to two drawers. Total height will increase about 220 mm.

### Division

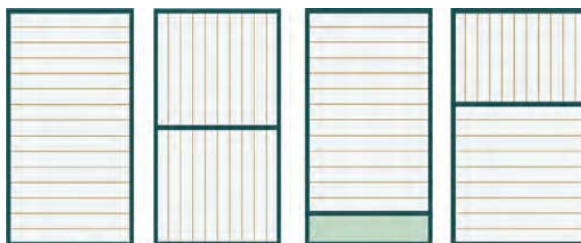

**NKV10**  
track width 330

**NKV20**  
track width 330

**NKV30**  
with X-ray boxes  
track width 330

**NKV40**  
DIN A4  
suspensions lengthways  
DIN A3  
suspensions crossways  
track width 330/440

Article Number	Cabinet Dimensions BxDxH mm
NKV10 / NKV20 / NKV20-1	745 x 400 x 520
NKVR10	815 x 400 x 570
NKV30 / NKV30-1	745 x 400 x 520
NKV40	780 x 500 x 560
Total dimensions incl. push bar BxDxH mm	
NKV10 / NKV20	840 x 460 x 900
NKV20-1 / NKV30-1	840 x 460 x 900
NKVR10	910 x 460 x 950
NKV30	840 x 460 x 900
NKV40	875 x 560 x 950

## Ergonomic Documentation Trolley

The EDW is for flexible usage in patient care and documentation. Its slanted surface allows an ergonomic and comfortable working process.

The lower range can be equipped with doors, open shelves, drawers or document folders. As an example EDW5310 has three drawers and one document folder. By default, our EDW are all equipped with a push bar.

The undercarriage is made up of a solid plastic sheet, which also serves as wall-stopper. Four castor wheels, Ø 125mm, with two brakes, guarantee easy use.

The cabinet consist of special high quality sheets and worktops of quality class E1 with a double-sided melamine resin coating and a two mm thick ABS-safety edge foil.

### Working surface

- ergonomically sloped for comfortable work positioning
- resistant to disinfectants
- standard colour: light grey (LG)
- edge veneer: light grey (LG)
- special colours on request

### EDW5310



### EDW5310

Image with optional accessory SPA1L



### EDW5102

Image with optional accessories HMF and BS4L



### EDW5102

Image with optional accessories HMF and BS4L



Cabinet Dimensions	Total Dimensions BxDxH mm
550 x 490 x 905	670x 570 x 1085

# Catheter Trolleys

## KW01

Image with  
BS4L and BS4R



## Catheter Trolley KW01

Intracardiac catheter require special storage conditions due to their lengths. The novocal catheter trolley enables a protected and organized storage. The superstructure of this trolley can accommodate 21 types of catheters. By default, our catheter trolley is equipped with two push bars attached to the left and right.

- stainless steel hooks to hang catheters
- each row contains of 7 hooks
- the cabinet is equipped with open shelves

The undercarriage is made up of a solid plastic sheet, which also serves as wall-stopper. Five castor wheels Ø 125mm, with two brakes, guarantee easy use.

The cabinet consists of special high quality sheets and worktops of quality class E1 with a double-sided melamine resin coating and a two mm thick ABS-safety edge foil.

## KW02



## Catheter Trolley KW02

The undercarriage is made up of a solid plastic sheet, which also serves as wall-stopper. The cabinet consists of special high quality sheets and worktops of quality class E1 with a double-sided melamine resin coating and a two mm thick ABS-safety edge foil. The trolley is equipped with six castor wheels, Ø 125 mm, two of them with brakes.

### Composition as follows:

Left side:

- 1 door
- girder support system for trays 300 x 400 mm (supply without modules)

Right side:

- 1 door
- girder support system for trays 600 x 400 mm (supply without modules)
- 4 pairs of telescopic extensions; each provides 7 pairs of hooks for catheters
- 

## KW02

Image with  
optional  
accessories  
BS6R, MTW  
and diff.  
Modules



Article Number	Total Dimension BxDxH mm
KW01	1120 x 790 x 1640
KW02	1132 x 570 x 1680



**CETOS1112**

Image with ZY and ZE, optional accessories ES2H, ESR and KKE



**CETOS1000**

- drawer for Laptops extendable to the right, lockable
- drawers are available in 3 different heights (total height: 9.0 RU)
- drawers on ball-bearing guide rails
- master lock/cylinder lock
- sides panels: standard colour: silver (coloured side panels optionally available)
- height adjustable superstructure with bin system for needles and syringes (double-row)
- disinfectant dispenser with drip pan
- standard euro-rack with glove box mounting and medibox on the left side
- waste collector on the right side

Patient Care and Nursing Trolleys  
autoclavable

**Mobile Functional Trolley with High Quality, Easy Care and Functional Synthetic Surface**

Phoenixcare is an association of two companies: One of them is a leading company in synthetics production, the other is an innovative and successful company in producing furniture for health care. This makes Phoenixcare to an expert in the are of patient care and nursing furniture.

All Phoenixcare products are made of a high quality, easy care and functional synthetic surface. They fulfill all requirements concerning hygienic management. The trolleys are easy to clean and autoclavable. Wheels can be removed for cleaning.

Images shown in this catalogue are just an extract of the whole series available. The trolleys can be equipped related to your in-

height adjustable superstructure for additional accessories



extendible drawer for Laptops





## Patient Care and Nursing Trolleys for Operating Room and Intensive Care

### CETOS1900

Image with optional accessories ES2H, DMS5, TS5, HSB1, MB, ESR and ZY



CETOS trolleys feature 20 % more loading capacity related to trolleys with the same required floor space. The light weight as well as the usage of double castor wheels guarantee easy handling. Nevertheless, all trolleys are very stable and will not tilt over.

### CETOS2000

Image with optional accessories SCHUETTE5, HSB1, ESS, KKE, GK, ZY and diff. Modules



### CETOS2000

- drawer for Laptops extendible to the right
- front can be closed by a jalousie
- Interior is equipped with 2 ISO modules (height: 50 mm), 2 ISO modules (height: 100 mm) and 1 ISO basket (height: 200 mm)
- Master lock with key
- standard euro-rack with catheter mounting on the left side
- 2 wire-netted stainless steel baskets on the right side
- low superstructure with bin system for needles and syringes (single-row) as well as glove box mounting

Article Number	Total Dimensions BxDxH mm
CETOS1000	950 x 690 x 1110
CETOS2000	950 x 690 x 1110

**Patient Trolley**

**PATW8301**

The patient trolley simplifies everyday processes concerning the security and storage of a patient’s property. The left side of the trolley provides hanging space for clothes, and includes a soft closing, 180 degree hinged door.

Three drawers are located on the right side which can be accessed from either side of the trolley to reduce unnecessary movement of the unit. The top drawer is equipped with a combination lock for security of a patients valuables, with a further two drawers below providing a variety of storage sizes. All drawers can be loaded with up to 35 kilos in weight

A height adjustable dinner tray is provided between two wooden upstands to the right side.

The cabinet consist of class E1 high quality sheets and worktops with a double-sided melamine resin coating and a two mm thick ABS-safety edge foil.

A special edge creates a seamless joint providing very hygienic, and easy to clean work surfaces to assist in maintaining a sterile environment. There is also a bottle storage facility on the worktop for a variety of uses.

The trolley base is made up of a solid plastic sheet, which also serves as a buffer for the unit to prevent damage, and is provided with five high quality 125 mm castor wheels with two brakes for guaranteed secure, easy, and silent use.

The trolley is equipped with a euro-rack which can be used to push the trolley.



Cabinet Dimensions	Total Dimensions BxDxH mm
840 x 500 x 1200	920 x 570 x 1380

# IT-Trolleys



## CW4210

Image with optional accessories MH, BS6L, SPA1 and ZE such as optional with PSS fitted



## CW4210



## Computer Trolley Series 4000

This computer trolley is equipped with a side-gated pull-out compartment for the keyboard, a mouse compartment as well as a monitor stand, which can carry up to 25 kg. On the back there are three compartments including cable bushings for storing your IT processors and equipment. The cabinet is lockable.

We are more than happy to pre-install any IT equipment you may require, ranging from HP Thin Clients and monitors to uninterruptible power supply systems.

The bottom part of the trolley can be designed according to your preferences - either with doors, normal drawers or drawers sized for records and files. Naturally, all drawers come as soft self-closing version and run on telescopic slides. Cabinet racks can be adjusted at different heights or taken out completely.

The cabinet is made of special sheets, quality class E1 with double-sided melamine resin coating and a two mm thick ABS-safety edge foil. Colours are available as per our colour chart. The worktop has rounded edges. By default, the trolley is equipped with a push bar.

The undercarriage is made of a solid plastic sheet. It also functions as wall stopper. Four castor wheels Ø 125 mm, with two brakes, guarantee easy use.

A suitable power supply can be found on page 63.

## CW4210 with integrated PSS



Cabinet Dimensions	Total Dimensions incl. monitor stand BxDxH mm
450 x 600 x 905	570 x 680 x 1500

Seating Stainless Steel Fabrications OP Equipment Storage / Transport Systems Waste Collectors Accessories ISO Trolleys IT Trolleys Patient Care and Nursing Trolleys Laundry Logistics

**Computer Trolley Series 5000**

This computer trolley is designed in such a way that it is primarily operated from the front. The upper part is an empty compartment, in which a laptop or a PC can be placed. This empty compartment can also be ordered as a keyboard shelf or as a drawer. Ventilation grilles are installed in the back and in the front to remove the heat. The lower part of the trolley is equipped with a pull-out shelf, on which optional the battery and the control unit can be accommodated (PSS see page 63). The front section of the trolley can also be equipped with two drawers.

All drawers come as soft self-closing version and run on telescopic slides.

The cabinet is made of special sheets, quality class E1 with double-sided melamine resin coating and a two mm thick ABS-safety edge foil. Colours are available as per our colour chart.

The undercarriage is made of a solid plastic sheet. It also functions as wall stopper. Four castor wheels Ø 125 mm, with two brakes to guarantee easy use.

A push bar is included.

A suitable power supply can be found on page 63.

**CW5202**

Image with BS4L



**CW5202**

with plenty of room for technology in the lower area



**CW5202**

Ventilation grilles installed in the back



Cabinet Dimensions	Total Dimensions BxDxH mm
550 x 490 x 905	670 x 570 x 1085

## IT-Trolleys

### CW6210

Image with optional accessories  
MH, BS4L,  
BS4R and ZY



### Computer Trolley Series 6000

This computer trolley is designed in such a way that it is only accessible at the front end. It has a monitor stand, which can carry up to 25 kg. The back end of the trolley has grilles to ensure proper circulation of air and ventilation of IT equipment.

The left side of the trolley has two 180 mm wide, 450 mm deep and 480 mm high racks. The racks are variable in height, thus all your IT components can be accommodated as needed.

This computer trolley is equipped with a pull-out compartment for the keyboard and mouse and is suitable for keyboards of up to 400 mm breadth. The bottom part of the trolley can be designed according to your preferences, either with doors, normal drawers or drawers sized for records and files.

All drawers come as soft self-closing version and run on telescopic slides.

The cabinet is made of special sheets, quality class E1 with double-sided melamine resin coating and a two mm thick ABS-safety edge foil. Colours are available as per our colour chart. The worktop has rounded edges.

The undercarriage is made of a solid plastic sheet. It also functions as wall stopper. Four castor wheels Ø 125 mm, with two brakes, guarantee easy use.

A push bar is included.

Cabinet Dimensions	Total Dimensions incl. monitor stand BxDxH mm
655 x 490 x 905	780 x 570 x 1500

**IT Trolley EDVW5400**

The undercarriage is made up of a solid plastic sheet, which also serves as wall-stopper. The cabinet consists of special high quality sheets and worktops of quality class E1 with a double-sided melamine resin coating and a two mm thick ABS-safety edge foil.

Drawers and document-folders are mounted on telescopic rails with a soft-air self-closing system. Four castor double-wheels Ø 125 mm, two with brakes, guarantee easy use.

- 1 push bar on the left side
- 1 open shelf, height: 192 mm (3.0 RU)
- 1 front-gated pull-out compartment for keyboard and mouse
- 3 drawers, height each 128 mm (2.0 RU)
- 1 drawer, height 288 mm (4.5 RU)
- all drawers with recessed handle
- fold-away working surface on the right side
- monitor mounting on the right side on top of the working surface

See page 63 for a power supply system.

**EDVW5400**

Image with optional accessories BS4L, TH, SPA1R and SLIDE15



**EDVW5400**

Image with optional accessories BS4L, TH, SPA1R and SLIDE15



Cabinet Dimensions	Total Dimensions incl. monitor stand BxDxH mm
550 x 490 x 905	670 x 570 x 1500

# IT Trolleys



**EDVW6102**  
Image with optional accessories BS4R and diff. modules



## IT Trolley EDVW6102

The undercarriage is made up of a solid plastic sheet, which also serves as wall-stopper. The cabinet consists of special high quality sheets and worktops of quality class E1 with a double-sided melamine resin coating and a two mm thick ABS-safety edge foil. Worktop with round edges.

Four castor double-wheels Ø 125 mm, two with brakes, guarantee easy use.

- 1 open shelf, height: 192 mm (3.0 RU) incl. 1 front-gated pull-out compartment for keyboard and mouse
- recessed handle at pull-out compartment for keyboard
- 2 doors (6 RU) and girder support for modules 600 x 400 mm (supply without modules)
- 1 shelf for technical equipment, can be folded away to the front, panel height 288 mm (4.5 RU)
- euro-rack on the right side
- on pair of hooks, stainless steel
- fold-away worktop on the left side
- monitor mounting on the right side on top of the working surface

See page 63 for a power supply system.

**EDVW6102**  
Image with optional accessories BS4R and diff. modules



Cabinet Dimensions	Total Dimensions incl. monitor stand BxDxH mm
656 x 490 x 905	7760 x 5700 x 1500

**LAW4210-S**

Image with optional accessories ABSTOP, ZE and SPA1L



**Laptop Trolley**

Our laptop trolleys are either equipped with a retractable and lockable laptop storage facility including an automatic lift system (-A), or with a side-gated pull-out compartment for the laptop (-S). Appropriate IT equipment can be sourced and supplied.

The lower part of the trolley can be provided with doors, standard drawers, or drawers for files and records.

Naturally, all drawers come as soft self-closing version and run on telescopic slides.

The cabinet is made of special sheets, quality class E1 with double-sided melamine resin coating and a 2 mm thick ABS-safety edge foil. Colours are available as per our colour chart. The worktop has rounded edges.

The undercarriage is made of a solid plastic sheet. It also functions as wall stopper. Four castor wheels, with two brakes, guarantee easy use (Ø 125mm).

A push bar is included.

**LAW4400-S**

Image with optional accessories ABSTOP and BS4L



**LAW4210-A**

Image with optional accessories ZE



**LAW4001-S**

image with optional accessories EAK, RGE, SPA1L, HMF



Cabinet Dimensions	Total Dimensions BxDxH mm
450 x 490 x 905	570 x 570 x 1085



# IT Trolleys

## Laptop Trolley with Height Adjustable Shelf

LAW4300H

The laptop trolley is equipped with an height adjustable shelf for best ergonomic working. The undercarriage is made up of a solid plastic sheet, which also serves as wall-stopper. The cabinet consists of special high quality sheets and worktops of quality class E1 with a double-sided melamine resin coating and a two mm thick ABS-safety edge foil.

Drawers and document-folders are mounted on telescopic rails with a soft-air self-closing system.

Four castor double-wheels  $\varnothing$  125 mm, two with brakes, guarantee easy use.

**Features:**

- without railing
- 1 height adjustable laptop shelf, dimensions: 500 x 510 mm (BxD); height adjustable: 925-1295 mm
- 3 drawers, each 157 mm (2.5 RU)



LAW4300H



Cabinet Dimensions	Total Dimensions BxDxH mm
450 x 490 x 525	570 x 570 x 925

**iPad Trolley**

Our iPad Trolley is an ergonomically formed ward round trolley which has a slanted working surface with an integrated iPad. The working surface is easily cleaned, and the equipment kept safe from any humidity entering. The iPad is locked away securely by a lock attached to the side of the trolley.

An integrated additional battery with 12.000 mAh adds up to 12 additional hours of battery life for working on the iPad. In this manner several duty shifts can be completed successfully using the iPad.

The undercarriage is made up of a solid plastic sheet. Four castor wheels Ø 125mm, with two brakes, guarantee easy use.

The bottom part of the trolley can be equipped with drawers, compartments, regular doors or foldable doors



**IPW4400**  
Image with optional accessory BS4L



**Battery Compartment**



Cabinet Dimensions	Total Dimensions BxDxH mm
450 x 490 x 905	570 x 570 x 1085

# IT Trolleys

## Power Supply System

Our power supply system consists of a base unit, an external control and display panel, all connection cables and an appropriate battery. The battery is available in different versions to suit your needs. Please contact us for available options.

This unit generates the required charge current while providing enough capacity for your IT unit. Load module is included.

With this battery solution you are able to work independently in your facility for hours. The control unit provides a visual and audible alarm for low battery level.

Charging can occur at any time via the corresponding charger cable. There is no interruption of power supply, which means that you can work more flexibly than ever. This system can be integrated into a wide range of our patient care and nursing trolleys.

The PSS is available for all computer and laptop trolleys and can also be retrofitted into existing trolleys

Further accessories can be found from page 71.

PSS



## PSS in Detail



PSS integrated in CW6210



## Control Unit installed at Cabinet



**DES11**  
Mobile,  
image with optional  
accessories  
DMS5, TSDESI and GK



**DES12**  
Floor model,  
image with optional  
accessories  
DMS5, TSDESI and  
GK



**Disinfection station DESI**

Virus infections are becoming more and more frequent. As preventive measure doctors and health experts recommend washing your hands regularly. However, this is not always possible due to lack of facilities.

Our disinfection station DESI can be used any time, any place and offers the perfect prerequisites for disinfection of hands. Protect yourself and your fellow people everywhere!

The disinfection station DESI is built of stainless steel.

You can add different accessories e.g. disinfectant dispenser (manual or automatic), drip pan or information/instruction labels to the stainless steel plate.

**DMS5A**  
incl. TS



It is also possible to add wire-netted baskets - either welded to the station or to be mounted with hooks.

The DESI is available in two versions:

DES11 refers to the mobile Version with four castor wheels, diameter 50 mm, two with brakes.

DES12 refers to the floor model.

Article Number	Total Dimensions BxDxH mm
DES11	405 x 436 x 1425
DES12	385 x 420 x 1350

# Disinfection

## Disinfection Centre DESICENTER

The disinfection center DESICENTER is attractive, modern and practical. The center is stable, nevertheless it is easy to use and applicable in various areas. Especially in areas where hygiene is very important, e.g. foyers in hospitals, retirement homes or doctors' offices.

The DESICENTER is available in polished stainless steel (DESICENTER-VA) as well as coloured and powder coated (DESICENTER-F). Choosable colours are: white, yellow, orange, red, green and blue.

**The DESICENTER will not tilt over. It is mounted on a solid ground plate with skid-proof rubber feet. On request, two additional wheels for transportation can be mounted.**

### DESICENTER-F

Image with optional accessories  
DMS5 and TSDESI



### DESICENTER-VA

Image with optional accessories  
DMS5 and TSDESI



Article Number	Total Dimensions BxDxH mm
DESICENTER-VA	400 x 600 x 1490
DESICENTER-F	800 x 500 x 1505

**Mobile 360° Sterilization Unit with UV-C Technology- up to 99,999% Sterility**

Without chemicals and without toxic compounds: The UV-C sterilization unit sterilizes all kinds of microbes in patients' room, operation rooms or other areas in hospitals and retirement homes which are contaminated.

Ultraviolet radiation has a disinfecting effect in the spectral range between 280 and 200 nm. The device makes use of this advantage and eliminates germs at 254 nm without ozone formation. Of course, all requirements for consumer protection and HACCP concepts are met.

**UEKG01**



**UEKG01**  
control unit



**The exact Dose makes the Difference!**

Small microorganisms are eliminated by a small dose of UV-C radiation. More complexly structured microbes require a higher dose of UV-C radiation to be eliminated. The high-energy radiation of the UV-C disinfection device sterilizes up to 99.999% of all germs on the most diverse surfaces, such as door handles, bed frames, mattresses, tables or telephone handsets, if the device is correctly placed in the room.

# Disinfection



## All Advantages at a Glance:

- comprehensive disinfection without the use of chemicals
- 360° sterilization by 8 UV-C emitters
- very economical
- user-friendly operation, cleaning and maintenance
- compact size, mobile and therefore easy to transport within all hospital areas
- low energy consumption
- safe shutdown
- short operating times of 5 to 20 minutes
- Lifetime UV-C lamp: 12,000 h
- optimal supplement to standard cleaning procedures, suitable for all surfaces such as e.g. mattresses, tables and chairs

The sensor range of the UV-C device is 4.2 meters:

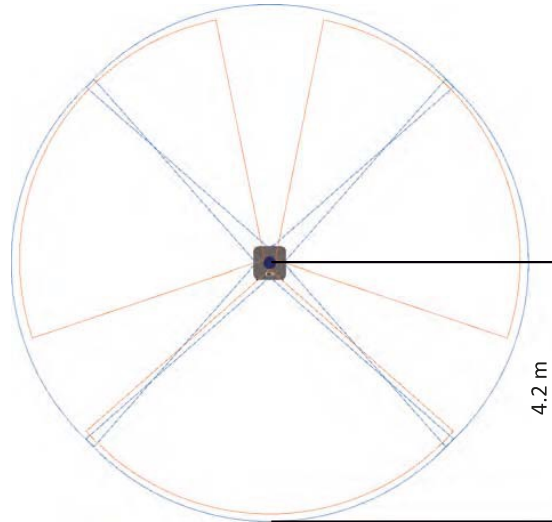

## UEKG01

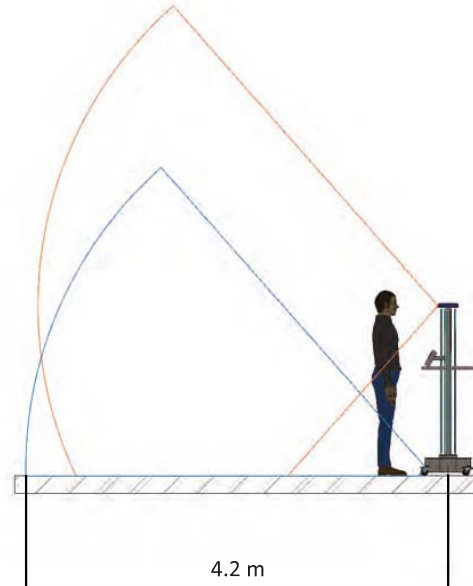

Article Number	Total Dimensions BxDxH mm
UEKG01	532 x 532 x 1726

Seating Stainless Steel Fabrications OP Equipment Storage / Transport Systems Waste Collectors Accessories ISO Trolleys IT Trolleys Patient Care and Nursing Trolleys Laundry Logistics

**MRSA Trolley, Series 1**



**MRSA Trolley: MRSA1**

The MRSA1 trolley matches all requirements related to hygienic management. The trolley has an extended back to mount various accessories, e.g. disinfectant dispenser, drip pan or glove box.

The undercarriage is made up of a solid plastic sheet, which also serves as wall-stopper. The cabinet consists of special high quality sheets and worktops of quality class E1 with double-sided melamine resin coating and a two mm thick ABS-safety edge foil. Four castor wheels Ø 125 mm, two with brakes, guarantee easy use.

There are two versions available:

- MRSA1F with two height adjustable shelves
- MRSA1M with girder support for ISO-modules format:

**MRSA1M**

Image with optional accessories DMS5, TS5, HSB1 and diff. modules



**MRSA1F**

Image with optional accessories DMS5, HSB1 and TEXT-MRSA



Cabinet Dimensions	Total Dimensions BxDxH mm
360 x 490 x 745	440 x 570 x 1660



# ISO Trolleys

## MRSA Trolley: MRSA2

The MRSA2 trolley matches all requirements related to hygienic management. The trolley has an extended open back to mount various accessories, e.g. disinfectant dispenser, drip pan or glove box.

The undercarriage is made up of a solid plastic sheet, which also serves as wall-stopper. The cabinet consists of special high quality sheets and worktops of quality class E1 with double-sided melamine resin coating and a two mm thick ABS-safety edge foil. Four castor wheels Ø 125 mm, two with brakes, guarantee easy use.

There are two versions available:

- MRSA2F with two height adjustable shelves
- MRSA2M with girder support for ISO-modules format:

## MRSA Trolley, Series 2

Image with optional accessories  
DMS5, TS5,  
HSB2 and  
TEXT-MRSA



## MRSA2F

Image with optional accessories  
DMS5, TS5,  
HSB2



## MRSA2M

Image with optional accessories  
DMS5, TS5,  
HSB2 and  
diff. modules



Cabinet Dimensions	Total Dimensions BxDxH mm
360 x 490 x 745	440 x 570 x 1485

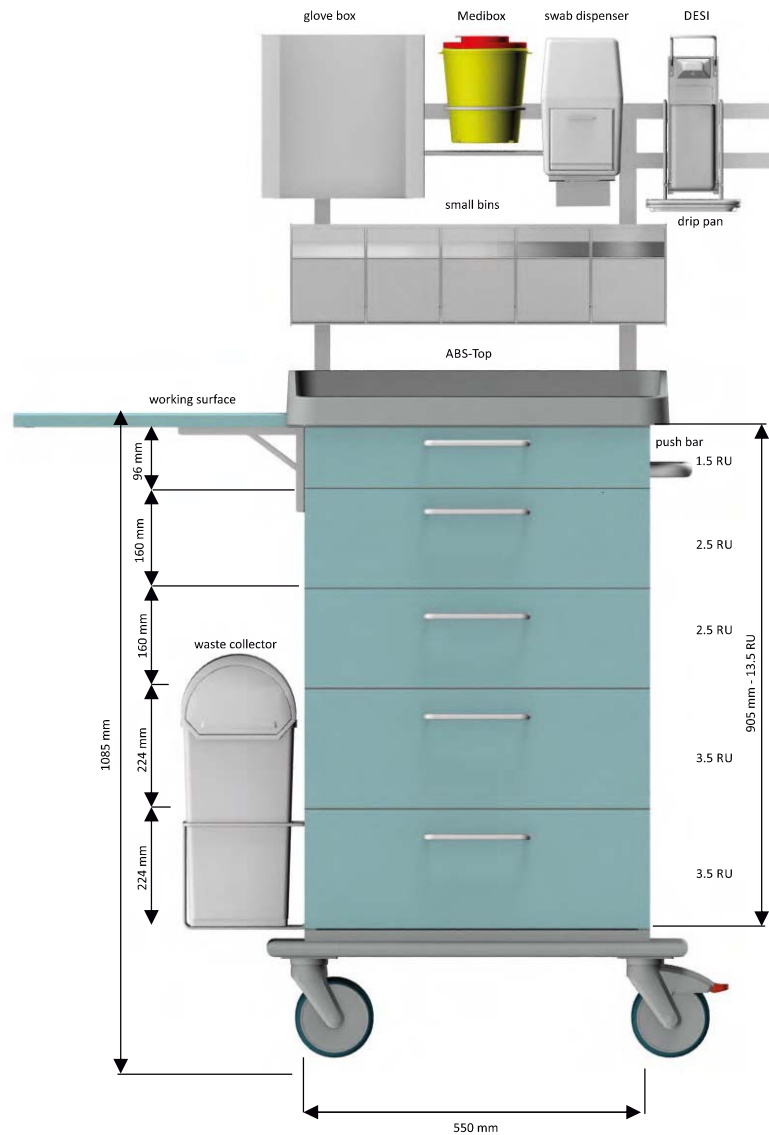

**The pictured trolley is equipped with the following accessories:**

- SPA1 (fold-away working surface)
- KB15 (waste collector/bin)
- ABS-TOP 5000
- BS (push bar)
- ES2 (euro-rack 2-fold, double-row)
- SCHUETTE5 (5 small bins)
- HSB2PAW (glove box 2-fold, euro-rack model)
- MB (medibox)
- TSE (dab dispenser, euro-rack model)
- DSM5PAW (disinfectant dispenser, 500 ml, euro-rack model)
- TSSPAW (drip pan, euro-rack model)

You will find suitable accessories for your laundry trolleys, IT trolleys and patient care and nursing trolleys on the following pages. It would be our pleasure to offer you a customised proposal based on your specific needs.

## Accessories

### SPA1

sideways fold-away working surface  
for installation on the left or right,  
operation with one hand, optionally with stainless steel plating



### SPA1H

sideways height-adjustable working surface  
SPA1H for installation on the left or right,  
operation with two hands, optionally with stainless steel plating.



### SPA2

extendable writing surface



### EAK

Stainless steel plating  
satin stainless steel, for the top work- and writing surface

Article no.	External dimensions (BxD mm)	Cabinet dimensions (BxD mm)
EAK3000	PAW3000: 404 x 508	PAW3000: 356 x 490
EAK4000	PAW4000: 498 x 508	PAW4000: 450 x 490
EAK5000	PAW5000: 598 x 508	PAW5000: 550 x 490
EAK6000	PAW6000: 704 x 508	PAW6000: 656 x 490
EAK7000	PAW7000: 760 x 508	PAW7000: 712 x 490
EAK8000	PAW8000: 848 x 508	PAW8000: 800 x 490
EAK9000	PAW9000: 948 x 508	PAW9000: 900 x 490



### ABSTOP

withstands disinfectants

Article no.	External dimensions (BxD mm)	Cabinet dimensions (BxD mm)
ABSTOP3000	PAW3000: 411 x 515	PAW3000: 356 x 490
ABSTOP4000	PAW4000: 505 x 515	PAW4000: 450 x 490
ABSTOP4000-600	PAW4000-600: 505x 625	PAW4000-600: 450 x 600
ABSTOP5000	PAW5000: 605 x 515	PAW5000: 550 x 490
ABSTOP6000	PAW6000: 711 x 515	PAW6000: 656 x 490
ABSTOP7000	PAW7000: 767 x 515	PAW7000: 712 x 490
ABSTOP8000	PAW8000: 855 x 515	PAW8000: 800 x 490
ABSTOP9000	PAW9000: 955 x 515	PAW9000: 900 x 490



### RGE

Tubular frame, stainless steel, also available in double-sided  
fashion, no ABS synthetic top available with this feature

Article no.	External dimensions (BxD mm)	Cabinet dimensions (BxD mm)
RGE3000	PAW3000: 396 x 470	PAW3000: 356 x 490
RGE4000	PAW4000: 490 x 470	PAW4000: 450 x 490
RGE5000	PAW5000: 590 x 470	PAW5000: 550 x 490
RGE6000	PAW6000: 696 x 470	PAW6000: 656 x 490
RGE7000	PAW7000: 752 x 470	PAW7000: 712 x 490
RGE8000	PAW8000: 840 x 470	PAW8000: 800 x 490
RGE9000	PAW9000: 940 x 470	



**SF**

Side compartments with stainless steel frame grid for SW600 and SW700



**MTW**

Girder support systems for ISO modules  
On request, available in different sizes for your nursing trolleys.



**QTS, LTS, RLS**

Divider for drawers  
LTS - lengthwise, made of aluminium, different sizes available  
QTS - transverse, transparent, different sizes available  
RL - slotted rail holder, fixed by glue, different sizes available



**BS**

Push bar  
BS4L/BS4R: push bar left / right for cabinet depth 490 mm  
BS6L/BS6R: push bar left / right for cabinet depth 600 mm



**TSE**

Swab dispenser euro-rack model



**IAB**

Surgical instrument container including stainless steel fitting



**MB**

Medibox, also called septobox or hallow needle box, made of polypropylene, yellow with red closing lid 1.5 l for used hollow needles, scalpels, etc.  
The box can be easily closed secure and watertight.



**MBHS**

Medibox mounting (set) available in different sizes, mounting as set, including 10 boxes of 1.5 l each



**MBHES**

Medibox mounting euro-rack model  
Custom-made sizes and forms on request.



## Accessories

### DMS

Disinfectant dispenser for 500 ml or 1000 ml, stainless steel lever for hand and elbow operation, aluminum body, mat silver anodised, to the front removable stainless steel pump with dosing limitation, available as euro-rack model (PAW), clip-on tubular model (SW) and wall model (W)  
The pump made of stainless steel (EPD) is also available separately.



### DMS5HH

Mounting for disinfectant dispenser, retrofit for existing euro-rack, for flexible mounting at the bottom or at the top



### DMS5RR

Disinfectant dispenser for round tube Ø 22-35 mm



### DMSA

automatic, with sensor (spare pump for pump exchange available)



### TS

Drip pan for DMS5 and DMS10, available as euro-rack model (PAW), tubular model (SW) and wall model (W) as well as a special model for DESI available



### EPD

Stainless steel pump with dosing limitation



### DMSV5 / DMSV10

Disinfectant closure plate  
DMSV5: for 500 ml DMS  
DMSV10: for 1000 ml DMS



Article Number	Disinfectant Dispenser
DMS5A	automatic DMS with sensor 500 ml
DMS5PAW	euro-rack model 500 m
DMS10PAW	euro-rack model 1000 ml
DMS5SW	tubular model (clip-on-version) 500 ml
DMS10SW	tubular model (clip-on-version) 1000 ml

Article Number	Disinfectant Dispenser
DMS5W	wall model 500 ml
DMS10W	wall model 1000 ml
DMS5HH	retrofit for existing euro-rack 500 ml
DMS10HH	retrofit for existing euro-rack 1000 ml
EPD	stainless steel pump w. dosing limitation

**ES1**  
Euro-rack, stainless steel,  
single-row



**ES1H**  
Euro-rack height adjustable, stainless steel,  
single-row



**ES2**  
Euro-rack double-row, stainless steel,  
image with optional accessory F-mounting



**ES2H**  
Euro-rack height adjustable, stainless steel,  
double-row



**FHL**  
F-mounting  
stainless steel,  
for installation  
on the left



**FHR**  
F-mounting  
stainless steel,  
for installation  
on the right



**TH**  
T-mounting  
stainless steel



**ESS**  
Euro-rack, sideways,  
stainless steel for lateral mounting  
ES5L - euro-rack mounting on the left  
ES5R - euro-rack mounting on the right



**EBHES**  
Stainless steel container for  
euro-rack, for surgical cutlery  
dimensions BxDxH = 250 x 150 x 300 mm



**UTBES**  
Implement basket, stainless steel,  
for euro-rack  
dimensions BxDxH = 80 x 80 x 90 mm



# Accessories

## HSB

Glove box mounting, stainless steel, for all current sizes, 1-4-fold also available as euro-rack model (PAW), tubular model (SW) and wall model (W)

**HSB1**



**HSB2**



**HSB3**



**HSB1Q**



**HSB3Q**



**HSB2Q**



**HSB4Q**



**Glove box mounting for euro-rack model (PAW), 1-4-fold, lengthwise and crosswise (-Q):**

Article Number	Total Dimensions BxDxH mm
HSB1PAW	134 x 92 x 237
HSB1QPAW	235 x 85 x 130
HSB2PAW	259 x 92 x 261
HSB2QPAW	470 x 85 x 130
HSB3PAW	134 x 92 x 391
HSB3QPAW	685 x 85 x 130
HSB4PAW (not shown)	134 x 92 x 520
HSB4QPAW	960 x 85 x 130

**Glove box mounting, tubular model (clip-on), 1-4-fold:**

Article Number	Total Dimensions BxDxH mm
HSB1SW	134 x 92 x 237
HSB2SW	259 x 92 x 261
HSB3SW	134 x 92 x 391
HSB4SW (not shown)	134 x 92 x 520

**Glove box mounting, wall model, 1-4-fold, lengthwise and crosswise (-Q):**

Article Number	Total Dimensions BxDxH mm
HSB1W/HSB1QW	134 x 92 x 237/235 x 85 x 130
HSB2W/HSB2QW	259 x 92 x 261/470 x 85 x 130
HSB3W/HSB3QW	134 x 92 x 391/685 x 85 x 130
HSB4W (not shown)/HSB4QW	134 x 92 x 520/960 x 85 x 130

**SCHUETTE3 - SCHUETTE6**

Bins 3-6-fold, for mounting to the euro-rack



**SCHUETTE3FIFO / SCHUETTE5FIFO**

Bins with FIFO-principle: First In - First Out  
3-fold and 5-fold



**GK**

wire-netted basket, for mounting sideways on PAW  
BxDxH = 400 x 160 x 170 mm



**PHE / PHK**

Coat hooks for mounting at back wall, available in stainless steel and plastic

**PHE** - stainless steel **PHK** - plastic



**NRS01**

Stainless steel kidney dish for euro-rack



**KKR**

Catheter tube round, wire netted, PE white  
**KKR01** - height 335 mm, Ø 85 mm  
**KKR02** -height 480 mm, Ø 100 mm



**KKE**

Catheter tube square stainless steel wire  
**KKE01** - 90 x 90 x 350 mm  
**KKED01** - central divider, 150 x 100 x 480 mm  
**KKED02** - central divider, 150 x 100 x 280 mm



**MUBH**

Mounting for mouth protection box to be mounted to euro-rack (**MUBHES**) special sizes on request





## Accessories

### KB9

synthetic waste bin  
9 Liters for SW and PAW

**KB9-E** - including stainless steel mounting



### KB15

synthetic waste bin  
15 Liters for SW and PAW

**KB15-E** - including stainless steel mounting



### KB8A

automatic sensor waste bin  
8 Liters for SW and PAW

**KB8A-E** - including stainless steel mounting



### SLIDE15 / SLIDE25

Waste bin 15 or 25 liters with knee operation  
colour: powdered RAL 7035 light grey  
dimensions: 460 x 400 x 170 mm / dimensions: 420 x 570 x 210 mm



### SLIDE15E / SLIDE25E

Waste bin 15 or 25 liters, stainless steel, with knee operation  
dimensions: 460 x 400 x 170 mm / dimensions: 420 x 570 x 210 mm

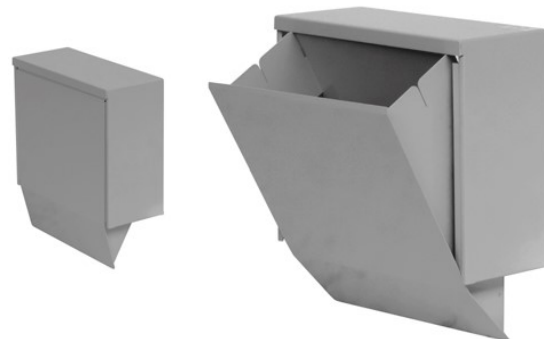

**ZY**  
Cylindrical lock



**ZS**  
Combination lock  
version depending on the product



**TPS01**  
Transponder lock  
compact and cable free furniture  
lock for all cabinets and drawers.  
Can be used without a key.



**BSML**  
B-Smart-Lock  
electronic numeric code pad



**ZE**  
Central lock



**IPH001**  
iPad mounting  
wall mounting



**MH**  
Monitor mounting



**MT1**  
Furniture safe  
Inside (BxDxH): 336 x 294 x 209 mm  
Outside (BxDxH): 402 x 376 x 278 mm



**MT2**  
Furniture safe  
Inside (BxDxH): 350 x 292 x 440 mm  
Outside (BxDxH): 435 x 382 x 528 mm



# Accessories

**IFH**  
 Infusion-bottle holder  
**IFHR** - to be mounted on the back of a trolley  
**IFHES** - euro-rack model



**IFHH**  
 Infusion-bottle holder  
 height adjustable

**SFH01**  
 Oxygen bottle holder



**HMF**  
 magnetic holder mounted on chassis



**DFST**  
 Door holder central,  
 for hinged-folding door

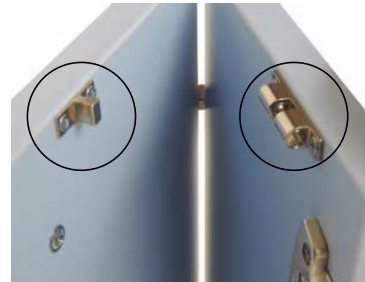

**ZFS**  
 Master adjusting device for patient care and nursing trolleys  
**ZFS04** master adjusting device with 4 limited wheels  
 for series PAW3000-6000  
**ZFS05** master adjusting device with 5 wheels, thereof 4 limited wheels  
 for series PAW7000-9000  
**ZFS+P** additional pedals



**ZFS**  
 detailed image



**LB-SE**

Wheel for multi-purpose trolleys  
material: polyurethane hard foam, Ø 150 mm  
1 set = 2 castor wheels and 2 wheels with brakes



**LRS75MRT**

MRI double castor wheel with brake,  
threaded pin, non-magnetic  
Ø 75 mm



**LRS125KU**

double castor wheel for PAW  
made of plastic with 2 brakes  
Ø 125 mm



**ADEF**

Shelf for defibrillator



**RP01**

Reanimation panel  
plastic, supply mounting for patient care and  
nursing trolleys PAW5000-9000,  
with three grips, 500 x 500 mm



**help**

Fire extinguisher system

**helpfs380**



fire extinguisher cabinet

hight 1027,5 mm  
bread 224,6 mm  
depth 433,4 mm

**helpav383**



element: first aid kit

total hight 1224 mm  
breadth 224,6 mm  
depth 433,4 mm

**helpad384**



element: defibrillator

total hight 1224 mm  
breadth 224,6 mm  
depth 433,4 mm



elements: defibrillator  
and first aid kit

total hight 1420 mm  
breadth 224,6 mm  
depth 433,4 mm

**helpvs381**



first aid cabinet

hight 527,5 mm  
breadth 224,6 mm  
depth 433,4 mm

**helpds382**



defibrillator cabinet

hight 527,5 mm  
breadth 224,6 mm  
depth 433,4 mm

ABS	ISO-module, diff. vers.	FM	shelf, diff. vers.
ABSK	ISO basket	FP	base plate
ABSTOP	ABS synthetic top	FS8100	tea cart
ADEF	tray for defibrillator	GAE	stainless steel closeable dustbin, diff. vers.
AHS	fold-out protection for S70/S70L	GB	stainless steel grid shelf, various sizes
AK	stainless steel pull-out clothing rail	GF	spring-base trolley
ASD/ASK	stopping device for wire-netted and plastic baskets	GK	wire-netted basketed, diff. vers.
ASM	stopping device for ABS- and PC-modules	GK2 - GK4	rubber toggle for linen nets, diff. vers.
ASPC4305-N	stopping device for PC-module PC4305-N	GSE	waste collector, diff. vers.
ATE	working and storage table, diff. vers.	GM	closed module trolley, diff. vers.
BS	push bar, diff. vers.	GS	aluminium cabinet trolley
BSML	B-Smart-Lock, electronic locking system	GTC/GTW/GTWK	transport trolley, diff. vers.
BSR	push bar for rack trolley	GTR2	skeleton container trolley
BTW01	trolley for abdominal bandages	H	textile protective cover for sorting racks, diff. vers.
CETOS	Phoenixcare-functional trolley, diff. vers.	help	fire extinguisher system
CI-...	OP equipment (shelves, cabinet, stools, tables)	HMF	magnetic holder mounted on chassis
CW	computer trolley, diff. vers.	HSB	glove box mounting, diff. vers.
D	set wire loops for drill machine	HW01	hook trolley
DD	drill machine	HWW	linen bags, warm- or hot water soluble
DDK	drill machine with chain	HZS	radiant heater for baby changing trolley
DEM	lid with magnet for all laundry trolleys	HZS-H	stainless steel mounting for radiant heaters
DESI	disinfection station	IAB	surgical instrument container with stainless steel fitting
DESICENTER	disinfection centre	IE	mobile instruments table, diff. vers.
DFST	door holder central, for hinged-folding door	IF	drip stand / IV-pole, diff. vers.
DFT	hinged-folding door	IFH	drip stand holder / IV-pole holder, diff. vers.
DIBE	white toggle with ring, diff. vers.	IFS	accessories for IV pole
DMS	disinfectant dispenser, diff. vers.	IPW	iPad-trolleys
DMSV	disinfectant closure plate, diff. vers.	IPH001	iPad mounting wall mounting
EAK	tubular frame, diff. vers.	K	linking feature
EBHES	stainless steel container for euro-rack	KB	synthetic waste bin, diff. vers.
EC/EE/EL	pedal dust bin, various sizes	KBW	synthetic base-tub, diff. vers.
EDVW	IT trolley, diff. vers.	KDH/KDS	loose plastic lid, diff. vers.
EDW	ergonomic documentation trolley	KF	clamping springs
EK	standardised label holders for rack systems	KI	lab coat stand
ENDO61000	endoscopic trolley	KKE, KKR	catheter tube, diff. vers.
ENDOHR	endoscopic bracket	KKL	brackets for border poles
EPD	stainless steel pump with dosing limitation for disinfectant dispenser	KNEBEL-ROT	toggle
ES	euro-rack, diff. vers.	KSR	combined sorting trolleys
EWK	stainless steel recyclables cabinet	KW01/KW02	catheter trolley, diff. vers.
F4/F6	compartment divider, various sizes	KW4/KW5	combined waste collector
FHL/FHR	F-mounting, mounted left/right	KW90	plastic tube, diff. vers.
FLEXISTORE	storage system FLEXISTORE	LAW	laptop-trolley, diff. vers.
		LGP	bag cassette for waste collector
		LTS	divider lengthwise, diff. vers.

## List of abbreviations



MB01	mangle rack	SB4	bedpans holder
MB	Medibox	SCHUETTE	bins, diff. vers.
MBH	Medibox mounting euro-rack model	SEALSAFE	waste sealing unit
MBHS	Medibox mounting (set)	SEG/SEM/SEV	multi-purpose trolley
MEDI	medicine trolley, diff. vers.	SF50	Side compartments
MH/MH-VESA	monitor holder, diff. vers.	SFH01	oxigen-cylinder holder
MOD	module trolley series, diff. vers.	SH	"S"-hooks
MT1, MT2	furniture safe, diff. vers.	SLAZ450	heavy load extention drawer
MRSA	MRSA-trolley, diff. vers.	SLIDE	hygienic waste bin „SLIDE“, diff. vers.
MTW	girder support	SM	drawer module, diff. vers.
MUBH	mounting for mouth protection box, diff. vers.	SPA	extendable working surface, diff. vers.
N	linen net, diff. vers.	SR	sorting rack trolley, diff. vers.
NA	stainless steel waste collector "Compact", diff. vers.	SR400	adhesive ring, diff. vers.
NKV	file and ward round trolley, diff. vers.	SRW	shoe rack, diff. vers.
NOVOVAC	vacuum device NOVOVAC	SSR	shock protection disc
NRS01	kidney dish	SST01	bowl retainer
NSW	system trolley modula, diff. vers.	ST	standing racks base unit
NW	stainless steel linen collector "Compact" and „Compact Plus“, diff. vers.	STE	front wall trolley
NWE	recyclables collector Series 2000	SW	laundry trolley, diff. vers.
NWK	stainless steel recyclables cabinet Series 3000	TBW/TW	tray trolley, diff. vers.
NWKA	aluminium recyclables cabinet	TE	wall mounting, diff. vers.
OMW	open module trolley, diff. vers.	TEXT-MRSA	Sticker MRSA
OPT	operation room step	TH	T-mounting
P	corner posts, diff. vers.	TK	transport box, diff. vers.
PACTOSAFE	waste sealing unit, Pactosafe	TPS01	transponder lock
PAW	patient care and nursing trolley, diff. vers.	TRE	stainless steel transport trolley, diff. vers.
PC	ISO-module, diff. vers.	TRE-AP	hinged shelf for TRE
PCT	divider for ISO-module, diff. vers.	TS	drip pan, diff. vers.
PHA4ES	brochure holder for euro-rack	TSE	swab dispenser
PHE	stainless steel coat hooks	TVD	pedal with dumping function, diff. vers.
PHK	plastic coat hooks	TW1/TW2	linen bag, diff. vers.
PSS	power supply system	UF	urine bottles wall wounting, diff. vers.
QTS	slotted rail holders, diff. vers.	UTBES	implement basket
R	rack trolley, diff. vers.	WKK	waste collector with colored synthetic container
RG	border grid, diff. vers.	WW1/WW2	stainless steel undercarriage with plastic tube
RGE	tubular frame, diff. vers.	WW	baby changing trolley, diff. vers.
RIFIX	directional locking	WICKELAUFLAGE	baby's changing pad, diff. vers.
RLS	slotted rail holder	WSR	shoe rack for wall mounting
RP01	reanimation panel	WSU	stainless steel wall shelf
RSB, RSD	border poles, diff. vers.	WTW	linen bag, diff. vers.
RUWI	roll-up utility trolley	ZE	cenrtal lock
RW01	room cleaning trolley	ZFS	master adjusting device
S40/S70	waste collector „Genius“	ZS	combination lock
		ZSE	room recyclable Collector, diff. vers.
		ZY	cylindrical lock



Our goal is to provide you products and solutions that meet the latest design, technology and functional requirements.  
Therefore, we have different processes to improve our products.

As part of these processes, there are optimizations as well as modifications or changes in production  
that are relevant to your products.

Product changes are a sign of improvement and advancing manufacturing, but may cause variations  
in color, style and texture of the products.

Errors and omissions excepted.



**MERIANTO OÜ**  
Siduri 3  
11313 Tallinn/Estonia Tel.:  
+372 50 181 04  
[sales@merianto.com](mailto:sales@merianto.com)  
[info@merianto.com](mailto:info@merianto.com)  
[www.merianto.com](http://www.merianto.com)  
[www.meriantomedical.com](http://www.meriantomedical.com)